

QuantStudio™ 3 and 5 Real-Time PCR Systems

INSTALLATION, USE, AND MAINTENANCE

Firmware v1.2.x

Publication Number MAN0010407

Revision C.0



The information in this guide is subject to change without notice.

DISCLAIMER

TO THE EXTENT ALLOWED BY LAW, LIFE TECHNOLOGIES AND/OR ITS AFFILIATE(S) WILL NOT BE LIABLE FOR SPECIAL, INCIDENTAL, INDIRECT, PUNITIVE, MULTIPLE, OR CONSEQUENTIAL DAMAGES IN CONNECTION WITH OR ARISING FROM THIS DOCUMENT, INCLUDING YOUR USE OF IT.

Limited Use Label License No. 474: Real-Time PCR System for Research Use Only

Notice to Purchaser: The purchase of this instrument conveys to the purchaser the limited, non-transferable right to use the purchased instrument only, under intellectual property rights that are owned and/or controlled by Life Technologies and relate specifically to the instrument. Purchase of the instrument includes the right to use the instrument for internal research and to perform services (including the right to report the results of services for a fee) by the purchaser only, but does not convey rights to use any other products, reagents, assays or methods such as the 5' nuclease assay process. The sale of this instrument is expressly conditioned on the purchaser not reselling, repackaging, or distributing this instrument, or any of its components, and no such rights are conveyed expressly, by implication, or by estoppel. For information on obtaining additional rights, please contact outlicensing@lifetech.com or Out Licensing, Life Technologies, 5791 Van Allen Way, Carlsbad, California 92008.

Limited Use Label License No. 572: Cy[®] and CyDye[®]

Notice to Purchaser: Cy[®] and CyDye[®] are registered trademarks of GE Healthcare.

Corporate entity

Life Technologies | Carlsbad, CA 92008 USA | Toll Free in USA 1.800.955.6288

TRADEMARKS

Cy is a trademark of GE Healthcare UK Limited. Adobe, Acrobat, and Reader are trademarks of Adobe Systems, Inc. Microsoft, Internet Explorer, and Windows are trademarks of Microsoft Corporation. Apple, Safari, and Macintosh are trademarks of Apple, Inc. Mozilla and Firefox are trademarks of Mozilla Foundation. TaqMan is a registered trademark of Roche Molecular Systems, Inc., used under permission and license. All trademarks are the property of Thermo Fisher Scientific and its subsidiaries unless otherwise specified.

©2015 Thermo Fisher Scientific Inc. All rights reserved.

Contents

About this guide	8
Revision history	8
Purpose	9
■ CHAPTER 1 Product information	10
Instrument hardware description	10
Instrument overview	10
Parts of the instrument	13
Software description	14
Instrument, desktop, and cloud software features	14
Folders, templates, experiments, and projects	15
Third-party software installation	16
Network connection options	16
Experiment types	17
■ CHAPTER 2 Start, sign on, and configure the instrument	19
Installation and instrument verification	19
Precautions for use	20
Power on the instrument	20
Parts of the home screen	21
Use the instrument without signing in	23
Create a new instrument profile	23
Sign In	23
Sign out	24
Link your instrument profile to your Thermo Fisher Cloud account	24
Link your instrument profile to Thermo Fisher Cloud	24
Create an instrument profile and link to Thermo Fisher Cloud	24
Configure instrument settings	25

■	CHAPTER 3	Create and run experiments on the instrument	28
	Workflow		28
	Options for running an experiment		29
	Create and run an experiment from a template		29
	Run an experiment from a saved file		29
	Repeat your last experiment run		30
	Edit an experiment before starting a run		31
	Define experiment properties		31
	Edit a method		32
	Define plate wells		35
	Load and unload a plate in the instrument		36
	View, pause, or stop a run		37
	View well details		37
	Pause or stop a run		37
	Adjust the graphical view of an experiment		37
	Lock the touchscreen during a run		38
	Transfer, view, or manage files and results		38
	Transfer experiment results		38
	View run history		38
	Manage template (.edt) files		39
■	CHAPTER 4	Calibrate and verify instrument performance	40
	Calibration and verification schedule		40
	Calibration descriptions		41
	View the calibration status and set reminders		41
	View calibration status and set reminders in the instrument		41
	View calibration status and set reminders in the Cloud		42
	Perform ROI/Uniformity, Background, and Dye calibrations		42
	Workflow: Calibration		42
	Prepare a calibration plate		43
	Perform calibrations		44
	View calibration images and transfer results to USB		46
	Troubleshoot calibration failure		47
	Identify contamination		47
	Create a background plate <i>(optional)</i>		48
	Perform instrument verification using RNase P plates		49
	Instrument verification description and schedule		49
	RNase P Instrument Verification Plates		49
	Analytical performance		50
	Installation specification		50
	Prepare an RNase P plate		50
	Perform RNase P verification		51
	Troubleshoot verification failure		53

Calibrate custom dyes	54
Custom dyes overview	54
Dilute the custom dye to an optimal concentration	54
Calibrate the custom dye	57
Calibrate for a custom melt curve experiment	60
■ CHAPTER 5 Maintain the instrument	62
Backup or restore the instrument	62
Decontaminate the sample block	63
Materials required	63
Clean the sample block	63
Solvents for cleaning the sample block	65
Replace the instrument fuses	65
Materials required	65
Replace the fuses	66
Power on or off, store, and move	66
Enable sleep mode	66
Power on the instrument	67
Power off the instrument	67
Prepare the instrument to ship, move, or store	67
Move the instrument	68
Return the instrument for service	68
■ CHAPTER 6 Profile and instrument configuration tasks	70
Initial start up	70
Manage profiles	71
Create an administrator profile	71
View all user profiles (Administrator only)	71
Manage all instrument profiles (Administrator only)	71
Edit a user profile	72
Enable SAE mode (Administrator only)	72
Require sign-in (Administrator only)	73
Enable remote instrument monitoring (Administrator only)	73
Update instrument software (Administrator only)	73
Restore factory defaults	74
Configure the network	74
Set up a wired connection	74
Set up a wireless connection	75
Select a Cloud region (Administrator only)	75
Manage the instrument name (Administrator only)	75
Set the date and time	76
Manage the Sign Out Timer (Administrator only)	76

- **APPENDIX A** Install and connect the instrument to a network 77
 - Workflow: Install and connect to a network 77
 - Before you begin 78
 - Unpack and install the instrument 78
 - Power on and follow the startup wizard 79
 - Connect the instrument and the computer directly or to a LAN 79
 - Instrument and computer connections 81
 - Download and install the QuantStudio™ Design and Analysis desktop Software 82
 - Computer requirements for the desktop software 82
 - Download the desktop software 82
 - Install the software 82
 - Networking 84
 - Supported network configuration options 84
 - Control and monitor networked instruments 85
 - About the Ethernet port 85
 - Firewall ports that must be open 85
 - Networking guidelines and best practices 85

- **APPENDIX B** Troubleshooting 87

- **APPENDIX C** Parts and materials 88
 - Kits, consumables, and accessories 88
 - 96-Well (0.2-mL) consumables 88
 - 384-well consumables 89
 - 96-Well Fast (0.1-mL) consumables 90
 - QuantStudio™ 3 and 5 Systems accessories 91
 - General-use materials and consumables 91

- **APPENDIX D** Instrument specification and layout 92
 - Configured system dimensions 93
 - Instrument clearances 94
 - Electrical requirements 94
 - Environmental requirements 95
 - Network requirements 95

■ APPENDIX E	Safety	97
	Symbols on this instrument	98
	Conformity symbols	99
	Safety alerts on this instrument	100
	Location of safety labels on the instrument	100
	Safety information for instruments not manufactured by Thermo Fisher Scientific	101
	Instrument safety	101
	General	101
	Physical injury	102
	Electrical	103
	Cleaning and decontamination	103
	Safety and electromagnetic compatibility (EMC) standards	103
	Safety compliance	104
	EMC	104
	Environmental design	105
	Chemical safety	105
	Biological hazard safety	106
	Documentation and support	107
	Related documentation	107
	Obtain information from the Help system	108
	Customer and technical support	108
	Limited product warranty	109
	Index	110

About this guide

Revision history

Revision	Date	Description
C.0	December 2015	Updates – describes new features in Firmware v1.2.x, including: <ul style="list-style-type: none">• Updated workflow to create an instrument profile• Streamlined workflow for connectivity to the Thermo Fisher Cloud• Improved display of VeriFlex™ Zones• Plate insert reminder before starting run• Support for 96-well Fast (0.1 mL) plates
B.0	September 2015	Updates – describes new features in Firmware v1.1.x, including: <ul style="list-style-type: none">• Experiment runs: monitor real-time data, edit cycle number and lock screen during a run, view end plot, and support for 384-well plates• File management: access Network folders, navigate folder structures and save templates on instrument, and perform batch actions for file management• Instrument configuration: support for Security, Audit, and e-Signature (SAE), smart monitoring, and choice of server region Includes information on software feature comparison, definitions of terms, parts of method, network connection options, experiment types, desktop software installation.
A.0	April 2015	New document. Describes installation, operation, and maintenance of the QuantStudio™ 3 and 5 Real-Time PCR Systems.

Purpose

This guide provides information about installing, using, and maintaining the QuantStudio™ 3 and 5 Real-Time PCR Systems.

Note: For information and instructions on performing experiments on these systems, refer to the *QuantStudio™ Design and Analysis desktop Software User Guide* (Pub. no. MAN0010408).



Product information

- Instrument hardware description 10
- Software description 14
- Network connection options 16
- Experiment types 17

Instrument hardware description

Instrument overview

The QuantStudio™ 3 and 5 Real-Time PCR Systems use fluorescent-based polymerase chain reaction (PCR) reagents to perform:

- Quantitative detection of target nucleic acid sequences (targets).
- Qualitative detection of targets (endpoint analysis).
- Qualitative analysis of the PCR product (post-PCR melt curve analysis).



The following fixed-block configurations are available:

QuantStudio™ 3 Real-Time PCR System	QuantStudio™ 5 Real-Time PCR System
<ul style="list-style-type: none"> • 96-Well VeriFlex™ 0.2-mL Block (4 Color) • 96-Well VeriFlex™ 0.1-mL Block (4 Color) 	<ul style="list-style-type: none"> • 96-Well VeriFlex™ 0.2-mL Block (6 Color De-coupled) • 384-Well Block (5 Color) • 96-Well VeriFlex™ 0.1-mL Block (6 Color De-coupled)

The instrument can be run directly from the touchscreen to create and start experiments. To design experiments or to analyze data, the instrument can be integrated with QuantStudio™ Design and Analysis Software (desktop or cloud).

An optional barcode scanner and optional wireless adapter can be purchased separately.

Instrument filters and supported dyes

System dyes

The QuantStudio™ 3 and 5 Systems use a coupled four-color, coupled five-color, or decoupled six-color filter set that supports the dyes shown in the following table and figure. For more information about the spectral dye calibration kits available for the QuantStudio™ 3 and 5 Systems, contact Support.

Peak channel	Color	Filter wavelength (nm) ^[1]		Pre-calibrated dyes	Example custom dyes
		Excitation	Emission		
x1-m1	Blue	470 ± 15	520 ± 15	FAM™ and SYBR™ Green	SYT09
x2-m2	Green	520 ± 10	558 ± 12	VIC™	HEX™, TET™, and JOE™ ^[2]
x3-m3	Yellow	550 ± 10	587 ± 10	ABY™, NED™, and TAMRA™	Cy ^{fi} 3
x4-m4	Orange	580 ± 10	623 ± 14	JUN™ and ROX™	Texas Red™
x5-m5	Red	640 ± 10	682 ± 14	Cy ^{fi} 5 and MUSTANG PURPLE™	LIZ™
x6-m6	Deep-Red	662 ± 10	711 ± 12	None ^[3]	Cy ^{fi} 5.5

^[1] The central wavelengths are the optimized wavelengths.

^[2] The HEX™ and TET™ dyes from Thermo Fisher Scientific fall within the emission wavelength range of the system, therefore they can be added and adapted for use in experiments on the system. To add any of these dyes to the Dye Library, perform a custom dye calibration.

^[3] This filter set currently does not support any dyes supplied by Thermo Fisher Scientific.

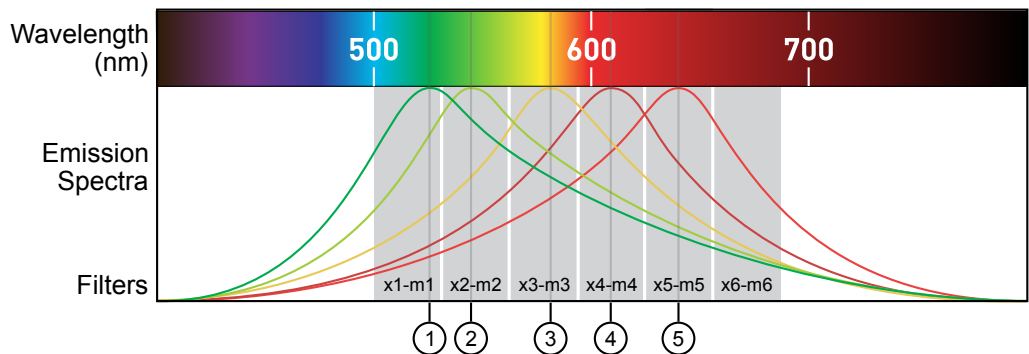

① x1-m1 — FAM™, SYBR™ Green

② x2-m2 — VIC™

③ x3-m3 — ABY™, NED™, Cy^{fi} 3, and TAMRA™

④ x4-m4 — JUN™, ROX™, and Texas Red™

⑤ x5-m5 — Cy^{fi} 5 and MUSTANG PURPLE™

Custom dyes

The QuantStudio™ 3 and 5 Systems can run assays designed with custom dyes (dyes not supplied by Thermo Fisher Scientific or dyes not pre-calibrated with the instrument). Custom dyes must excite between 455 – 672 nm and emit between 505 – 723 nm. Select a custom dye that does not overlap with other dyes used in an experiment (see the filter-wavelength table in “System dyes” on page 11).

To use a custom dye and add it to the Dye Library, perform a custom dye calibration (see “Calibrate custom dyes” on page 54).

About data collection

The instrument collects raw fluorescence data at different points during the PCR cycle, depending on the type of run performed.

When you create an experiment template (.edt file) in the desktop or cloud software, you can customize the optical filter channels through which the instrument collects data. You can specify a filter channel set for all PCR thermal protocols and, optionally, a different filter set for the melt curve stage(s).

Run type	Experiment type	Data collection point
Real-time	<ul style="list-style-type: none"> Standard curve Relative standard curve Comparative C_T ($\Delta\Delta C_T$) Melt curve 	<p>During the thermal cycling protocol.</p> <p>Typical timing is to collect data at each cycle of a PCR stage or continuously during a melt stage.</p>
Post-PCR (endpoint)	<ul style="list-style-type: none"> Genotyping Presence/ Absence 	<ul style="list-style-type: none"> After thermal cycling is completed. For Presence/Absence and Genotyping experiments, data collection before the PCR cycle is optional, but recommended. <i>[Optional]</i> Before thermal cycling starts. Collecting data during the run can confirm genotyping results by viewing traces in allelic discrimination plots or viewing genotyping calls at earlier cycles.

Blocks with VeriFlex™ Zones

Applied Biosystems™ VeriFlex™ technology provides independent temperature zones that offer enhanced functionality and precise control over your qPCR runs.

QuantStudio™ 3 System	QuantStudio™ 5 System
Three programmable VeriFlex™ Zones.	Six programmable VeriFlex™ Zones. ^[1]

^[1] Only applicable for 96-well 0.2-mL and 0.1-mL blocks.

These independent zones are ideal for qPCR optimization or the ability to run multiple experiments in the same run. Unlike standard gradients which give a sigmoidal temperature curve across the columns, blocks with VeriFlex™ Zones help deliver accurate temperatures across every zone.

Parts of the instrument

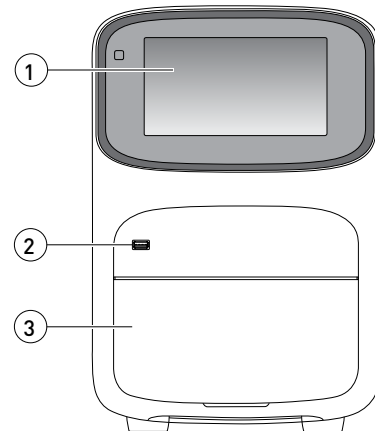

- ① **Touchscreen** – Controls the instrument.
- ② **USB port** – For connection to an external network drive, jump drive, or other external data storage device.
- ③ **Instrument drawer** – Contains sample plate.

The instrument includes three additional USB ports on the back of the instrument. The instrument recognizes only one external storage device at a time for data transfer.

Software description



Instrument, desktop, and cloud software features

The instrument software and the QuantStudio™ Design and Analysis Software (desktop and cloud) include the features described below.

Feature	Instrument	Desktop	Cloud
Use as guest (no sign in)	✓	✓ ^[1]	—
Create templates (unlocked or locked)	—	✓	✓
Edit unlocked templates	✓	✓	✓
Edit locked templates (password assigned by template creator required)	—	✓	✓
Load system or user-created templates (.edt file) to instrument	✓	✓	—
Change experiment settings in template (.edt file) loaded on the instrument Settings that can be changed in a locked template (no password required): <ul style="list-style-type: none"> • Properties: All settings • Method: No changes allowed • Plate: Sample names Settings that can be changed in an unlocked template: <ul style="list-style-type: none"> • Properties: All settings • Method: All settings • Plate: Sample names 	✓	—	—
Load plate in instrument	✓	—	—
Start run	✓	✓	—
View real-time data during a run	✓	✓	✓
View instrument status (running, calibration needed, and so on)	✓	—	✓
Analyze results	—	✓	✓
Set calibration reminders	✓	—	✓
Review exported calibration or RNase P verification results	—	✓	✓ (only RNase P)

^[1] Login required if the Security, Audit, and e-Signature (SAE) module is enabled (QuantStudio™ 5 Systems only)

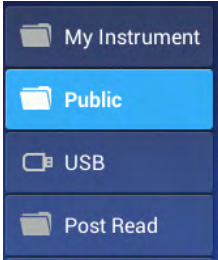
Folders, templates, experiments, and projects

Term	Definition	Supported in
Folders in Load Experiment 	Location in which you can store templates (.edt files) on the instrument: <ul style="list-style-type: none"> • My Instrument – Displayed if you are signed in • Public – Location in which all experiments run by guest users are stored • USB – USB for manual transfer to and from a computer • Post Read – If you run an endpoint experiment, the pre-read experiment is automatically saved in this folder for post-read analysis 	Instrument
Experiment Template File (.edt) 	Default settings for an instrument run, can be modified before instrument run. Two types: <ul style="list-style-type: none"> • Factory-provided, accessed from Open Template (instrument) or Create Experiment (desktop or cloud) • User-created, accessed from Load Experiment 	Instrument Desktop Cloud
Experiment Run File (.eds)	Settings and data for a completed instrument run.	Instrument Desktop Cloud
Project 	Function in the Cloud Data Manager that is used for secondary analysis applications. Does not apply to the QuantStudio™ Design and Analysis cloud Software, which is a primary analysis application.	Cloud

Template and experiment components	Instrument	Desktop	Cloud
Properties	<ul style="list-style-type: none"> • Experiment file name • Reagent information (Reagent barcode, Lot#) • Plate barcode • Data destination (location for auto-transfer of data) • Comments (Tags are not used at this time) 	<ul style="list-style-type: none"> • Experiment file name • Plate barcode • User name • Instrument type • Block type • Experiment type • Chemistry (reagent information) • Run mode • Comments • <i>{Cloud software only}</i> Notifications 	
Method	Thermal cycling conditions	Thermal cycling conditions	

Template and experiment components	Instrument	Desktop	Cloud
Plate	Sample names You cannot edit targets/SNP assays or tasks on the instrument.	Define and assign samples, targets or SNP assays, and tasks in the Quick Setup and Advanced Setup panes of the Plate tab.	
Run	Start and monitor a run in progress View: Time remaining and Temperature, Method, Plots Pause, Resume, Stop a run	Start and monitor a run in progress View: Time remaining and Temperature, Method, Plots	Monitor a run in progress (link to Thermo Fisher Cloud Instrument Details) View: Time remaining and Temperature, Method, Plots
Results	Not applicable	Review plots	
Export	Not applicable	Export results	



Third-party software installation

Before you install third-party software on the computer running the QuantStudio™ desktop Software, confirm that the third-party software will not:

- Restrict Ethernet communication.
- Interfere with instrument or computer operation.

Network connection options

You can connect a QuantStudio™ 3 or 5 Instrument to a network or computer in the configurations listed below. For specific information on networking, see “Networking” on page 84.

Direct connection	Local area network (LAN) connection	Cloud connection
wired	wired <i>or</i> wireless	wired <i>or</i> wireless
		

Experiment types

Purpose	Description
Standard Curve experiment	
Determines absolute target quantity in samples.	<ol style="list-style-type: none"> 1. The software measures amplification of the target in a standard dilution series and in test samples. 2. The software generates a standard curve using data from the standard dilution series. 3. Using the standard curve, the software interpolates the absolute quantity of target in the test samples.
Relative Standard Curve experiment	
Determines relative target quantity in samples.	<ol style="list-style-type: none"> 1. The software measures amplification of the target of interest and of an endogenous control target in a standard dilution series, in a reference (calibrator) sample, and in test samples. The endogenous control is a target that is expressed equally in all samples; examples of endogenous controls are β-actin, GAPDH, and 18S ribosomal RNA. The software can algorithmically incorporate multiple endogenous control targets in relative quantification calculations. The reference sample is used as the basis for relative quantification results (or 1\times sample). For example, in a study of drug effects on gene expression, an untreated control is an appropriate reference sample. 2. The software generates standard curves for the target of interest and the endogenous control using data from the corresponding standard dilution series. 3. Using the standard curves, the software interpolates the quantities of the target of interest and the endogenous control in each sample. The target quantity in each sample is then normalized to the endogenous control quantity in the sample. 4. To determine the relative quantity of the target in test samples, the software divides the normalized target quantity in the sample by the normalized target quantity in the reference sample.
Comparative C_T ($\Delta\Delta C_T$) experiment	
Determines relative target quantity in samples.	<ol style="list-style-type: none"> 1. The software measures amplification of the target of interest and of an endogenous control target in a reference (calibrator) sample and in test samples. The endogenous control is a target that is expressed equally in all samples; examples of endogenous controls are β-actin, GAPDH, and 18S ribosomal RNA. The software can algorithmically incorporate multiple endogenous control targets in relative quantification calculations. The reference sample is used as the basis for relative quantification results (or 1\times sample). For example, in a study of drug effects on gene expression, an untreated control is an appropriate reference sample. 2. The measurements for the target of interest are normalized to the endogenous control. 3. To determine the relative quantity of the target in test samples, the software compares the normalized C_T (ΔC_T) for the sample to the normalized C_T (ΔC_T) for the reference sample.

Purpose	Description
Genotyping experiment	
Detects single nucleotide polymorphism (SNP) variants of a target nucleic acid sequence.	Genotyping experiments use preformulated TaqMan™ SNP Genotyping Assays that include: <ul style="list-style-type: none"> • Two sequence-specific primers for amplification of sequences containing the SNP of interest. • Two allele-specific TaqMan™ probes for Allele 1 and Allele 2. <ol style="list-style-type: none"> 1. The software normalizes the fluorescence of the reporter dyes to the fluorescence of the passive reference dye in each well. 2. The software plots the normalized intensities (Rn) of the reporter dyes in each sample well on an Allelic Discrimination Plot, which contrasts the reporter dye intensities of the allele-specific probes. 3. The software algorithmically clusters the sample data, and assigns a genotype call to the samples of each cluster according to its position on the plot.
Presence/Absence experiment	
Determines the presence or absence of a target nucleic acid sequence in a sample.	The software calls the target present or absent based on an algorithmically determined call threshold. (The call threshold is different from the C _T threshold; the C _T threshold is not used to make calls.)
Melt Curve experiment	
Determines the melting temperature (T _m) of the amplification products of a PCR reaction that used SYBR™ Green dye.	In the software, Melt Curve analysis is included in the default run method for any experiment type that uses SYBR™ Green reagents.



Start, sign on, and configure the instrument

■ Installation and instrument verification	19
■ Precautions for use	20
■ Power on the instrument	20
■ Parts of the home screen	21
■ Use the instrument without signing in	23
■ Create a new instrument profile	23
■ Sign In	23
■ Sign out	24
■ Link your instrument profile to your Thermo Fisher Cloud account	24
■ Configure instrument settings	25

Installation and instrument verification





Before the first use of the instrument:

- Install the instrument (see “Unpack and install the instrument” on page 78).
- Verify instrument performance (see “Perform instrument verification using RNase P plates” on page 49).

Note: Instruments are factory calibrated, so no calibration is necessary at installation. However, we recommend that you verify instrument performance before using the instrument.

Note: Regular calibration and verification should be performed according to the “Calibration and verification schedule” on page 40.

Precautions for use

-
-  **CAUTION! PHYSICAL INJURY HAZARD.** Do not remove the instrument cover. There are no components inside the instrument that you can safely service yourself. If you suspect a problem, contact technical support.
-
-  **CAUTION! FIRE HAZARD.** For continued protection against the risk of fire, replace fuses only with listed and certified fuses of the same type and rating as those currently in the instrument.
-
-  **CAUTION! PHYSICAL INJURY HAZARD.** During instrument operation, the sample block temperature can reach 100°C. Allow it to cool to room temperature before handling.
-
-  **CAUTION!** Before using a cleaning or decontamination method other than those recommended by Thermo Fisher Scientific, confirm with Thermo Fisher Scientific that the proposed method will not damage the equipment.
-
-  **CAUTION!** Use flat caps for 0.2 mL tubes and 0.1 mL tubes. Rounded caps can damage the heated cover.
-

Power on the instrument

To power on the instrument from a powered-off state:

1. Touch anywhere on the touchscreen to determine if the instrument is in sleep mode. If the home screen displays, the instrument is already powered on.
2. If the home screen does not display, power on the instrument by pressing the switch on the rear panel.

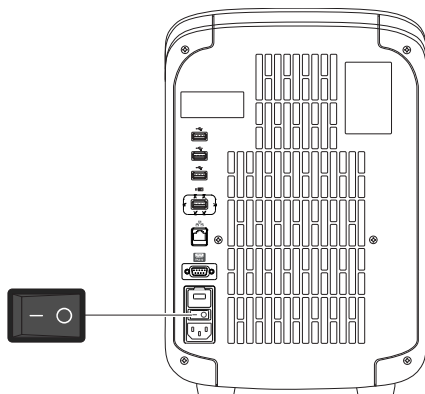

The instrument is ready to use when the home screen is displayed.

If left unattended (for about two hours), the instrument automatically enters sleep mode (enabled by default) to conserve power. Refer to the touchscreen Help system for step-by-step instructions for changing the sleep mode setting.









Parts of the home screen



- ① Avatar and Instrument name
- ② Eject icon
- ③ Help icon
- ④ Status dial
- ⑤ Current user name; instrument block type
- ⑥ Settings button
- ⑦ Buttons for accessing .edt files
- ⑧ Connectivity icons
- ⑨ Sign In (or My Profile) button

Table 1 Parts of the home screen

Element of the home screen	Function	For more information, see...
Avatar and Instrument name	Set by the administrator to uniquely identify instrument.	"Manage the instrument name (Administrator only)" on page 75.
Eject icon	Touch to open or close the instrument drawer.	—
Help icon	Touch to launch the touchscreen Help system to access step-by-step instructions.	—

Element of the home screen	Function	For more information, see...
Status dial	<ul style="list-style-type: none"> When the instrument is in use – Displays the sample block temperature, the elapsed run time, and the run status. You can swipe the dial to the left or touch  to access real-time views of the run. When the instrument is not in use – Displays Set up run. You can start a run by touching the status dial. When the instrument is locked – Displays a lock icon () within the status dial. 	—
Current user name and block type	<p>Displays the user name of the current signed-in user and the instrument block type.</p> <p>Note: If no user is signed-in, the instrument defaults to the Guest profile.</p>	—
Settings button	Touch  Settings to configure, calibrate, or learn about the instrument.	“Configure instrument settings” on page 25.
Buttons for accessing experiment and template files	Load Experiment – Touch to open a user-created .edt file from a Cloud account, USB, instrument folder, or network drive.	“Run an experiment from a saved file” on page 29.
	Open Template – Touch to open a system .edt template file.	“Create and run an experiment from a template” on page 29.
	Run Last – Touch to open the last .edt file run on the instrument. <ul style="list-style-type: none"> If you are signed-in, the file opened will be the last file you ran when signed-in. If you are not signed-in, the file opened will be the last file the guest profile ran. 	“Repeat your last experiment run” on page 30.
Connectivity icons	<ul style="list-style-type: none">  – The instrument is connected to a wired network.  – The instrument is wirelessly connected.  – A USB drive is plugged into the instrument.  – The instrument is linked to a Cloud account. 	—
Sign In button (My Profile button when a user is signed in)	<ul style="list-style-type: none"> Touch  Sign In to sign into an instrument profile and link to a Cloud account. Touch  My Profile to change instrument profile settings, link to a Cloud account, or lock the instrument during a run. 	“Sign In” on page 23.

Use the instrument without signing in

If the instrument is configured by an Administrator to allow guest access (**⚙ Settings ▶ Manage Users ▶ Sign In Required** set to off), you can use the instrument without signing in.

If you do not sign in to the instrument:

- All actions are logged to Guest user profile.
- You have access only to the Public folder for selecting and storing experiments.
- You cannot transfer data to the Cloud (only to USB or network drive).

Create a new instrument profile

In the home screen:

1. Touch  **Sign In**.
2. Touch **Get Started**.
3. Touch **Name**, then enter a username and touch **Done**.
4. Touch **PIN Code**, then enter a four-digit numerical password and touch **Enter**.
Note: Touch the **Show PIN** checkbox to switch PIN display on or off.
5. Touch **Confirm PIN** and repeat the previous step.
6. Touch **Create profile**.
Note: “Link your instrument profile to your Thermo Fisher Cloud account” on page 24 at this point, or you can link after signing in.
7. “Sign In” on page 23 to the profile you just created.

Sign In

“Create a new instrument profile” on page 23 before signing into the instrument.

In the home screen:

1. Touch  **Sign In**.
2. Touch **Sign In**, then select your username.
3. Enter your PIN, then touch **Enter**.

“Link your instrument profile to your Thermo Fisher Cloud account” on page 24 once signed in.

Sign out

In the home screen:

1. Touch  **My Profile**.
2. Touch **Sign Out**.

Link your instrument profile to your Thermo Fisher Cloud account

There are two ways to link an instrument profile to a Thermo Fisher Cloud account:

“Link your instrument profile to Thermo Fisher Cloud” on page 24

“Create an instrument profile and link to Thermo Fisher Cloud” on page 24

Linking your instrument profile to your Cloud account allows you to:

- View instrument status from the Cloud.
- Download templates stored in your Cloud account to the instrument.
- Transfer results from the instrument to your Cloud account.

Link your instrument profile to Thermo Fisher Cloud

1. “Sign In” on page 23 to your instrument profile.
2. Touch  **My Profile**.
3. Touch **Cloud**.
4. Enter your Thermo Fisher Cloud username and password, then touch **Link Account**.
5. Touch **Done** to exit the confirmation screen.

Your instrument profile will link to your Thermo Fisher Cloud account.

Create an instrument profile and link to Thermo Fisher Cloud

1. Complete step 1 to step 6 in “Create a new instrument profile”, or continue from “Initial start up” on page 70.
2. In the Get Started – Cloud screen, enter your Thermo Fisher Cloud username and password.
3. Touch **Link Account**.

Your instrument profile will link to your Thermo Fisher Cloud account.

Configure instrument settings

Touch  **Settings** in the home screen to configure settings as needed.

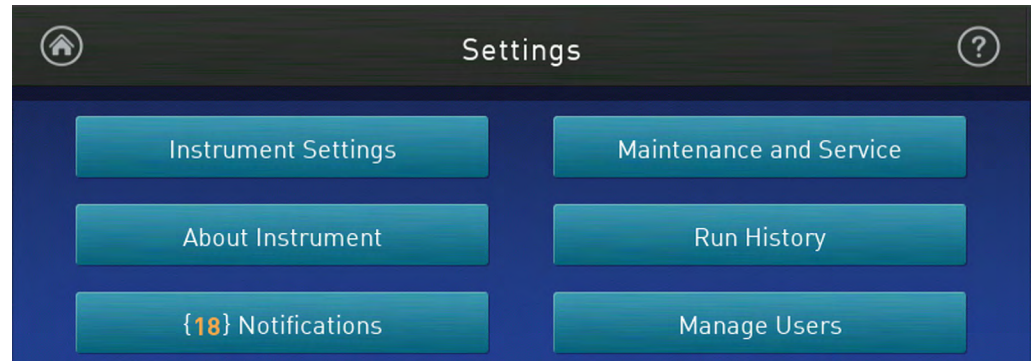

Touch  for step-by-step instructions on configuring settings.

Options	Description
Instrument Settings	
Instrument Name (Administrator only)	Instrument name. If connected to a network, the instrument name must be unique. <i>(Optional)</i> Add an avatar image for the instrument (.jpg, .png, or .gif) from a USB.
Sleep Mode	Enable the instrument to enter a standby mode after a set length of inactivity.
Heated Cover Temperature	Set the temperature of the heated cover for instrument operation and standby mode. Enable heated cover to automatically turn off during standby mode.
Network Drive	Specify a default network location for the signed-in user.
Insert Plate Reminder	Enable a reminder to insert a plate before starting a run from the instrument.
OEM Connection Only (Administrator only)	Required for API access to the instrument. When enabled, the QuantStudio™ Design and Analysis Software cannot connect to the instrument. API access to the instrument is exclusive to authorized OEM partners.
Cloud Region (Administrator only)	Specify the regional server location to access the Thermo Fisher Cloud Dashboard. Note: Once you set a Cloud region, restore factory defaults to change the region.
Date/Time	Set time zone and date and time formats.
Network Connection	Set wired or wireless network connection for the instrument.
Restore Factory Defaults	Restore the instrument to the factory settings. IMPORTANT! Back up the instrument before restoring factory defaults (see “Backup or restore the instrument” on page 62). Note: When you restore an instrument to its factory defaults: <ul style="list-style-type: none"> • User profiles and files stored on the instrument are deleted, including all user-created .edt and .eds files and any custom dye and custom melt calibrations. • System templates and factory calibrations remain on the instrument.

Options	Description
SAE Mode (Administrator only) (QuantStudio™ 5 Systems only)	When enabled: <ul style="list-style-type: none"> The home screen displays SAE mode. Runs must be started from the desktop software. The instrument locks out access to load experiments, open template, run last, start a run, change instrument name and date/time. Only an administrator can perform calibrations. A user can monitor a run and view the method from the instrument touchscreen.
About Instrument	
About Instrument	Displays the instrument Model Name, Block Serial Number, and Firmware Version.
License Agreement	Displays the End User Software License Agreement and the Limited Product Warranty. You can export the License Agreement to a USB drive.
Notifications	
—	Enable home screen notifications of instrument errors and software updates. This function is not related to the Notifications function in the cloud software. The number of new, unviewed notifications displays over Settings in the home screen.
Maintenance and Service	
Software Update (Administrator only)	Update the instrument software.
Monitoring (Administrator only)	Enable: <ul style="list-style-type: none"> Remote Monitoring Service to automatically send critical device statistics to Thermo Fisher Scientific (does not monitor or send data). Thermo Fisher Scientific Cloud Monitor to allow real-time monitoring of instrument runs from a Cloud account.
Instrument Statistics	Displays instrument usage information: Block Cycle Count and LED Life.
Calibrations	<ul style="list-style-type: none"> Perform calibrations <ul style="list-style-type: none"> ROI and Uniformity Dye Custom (including Background calibration) View calibration history and set calibration reminders in History and Reminders
RNase P Verification	Perform instrument verification using an RNase P plate.
Self Verification Test	Check the instrument hardware functions.
Log	View and export Instrument Log.
Backup / Restore	<ul style="list-style-type: none"> Backup Instrument Restore a Backup (Administrator only)
Ship Prep Mode	Place the instrument in a safe state for shipping, moving, or long-term storage.

Options	Description
Run History	
—	<p>Displays the experiments run on the instrument and whether the data was transferred.</p> <p>Note: Experiments run while a user is signed-in can only be viewed or transferred by that user or an administrator.</p> <p>Touch an experiment to view experiment run details and to transfer or delete .eds file.</p>
Manage Users	
Sign In Required (Administrator only)	Enable the restriction of instrument use to only signed-in users (disables Guest profile use).
Sign Out Timer (Administrator only)	Set the duration of inactivity before a user is automatically signed out.
Manage Profiles (Administrator only)	<ul style="list-style-type: none"> • Instrument • Cloud • All Profiles <p>Displays the profile information for the instrument and the associated Cloud account.</p>

3

Create and run experiments on the instrument

- Workflow 28
- Options for running an experiment 29
- Edit an experiment before starting a run 31
- Load and unload a plate in the instrument 36
- View, pause, or stop a run 37
- Transfer, view, or manage files and results 38

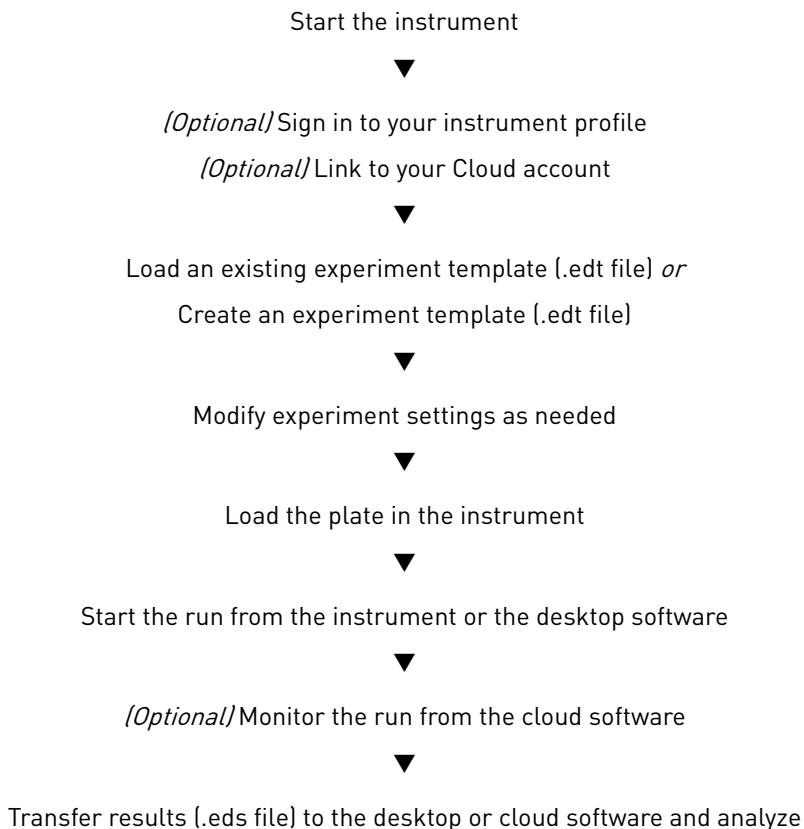

Workflow



Options for running an experiment









Create and run an experiment from a template

In the home screen:

1. Touch  **Open Template**.
2. *(Optional)* Touch an experiment category in the left column.
3. Touch the experiment file name.
4. *(Optional)* “Define experiment properties”, including Run File Name (.eds file name), Plate Barcode, Reagent Information, and Data Destination.
5. *(Optional)* “Edit a method” on page 32.
 - Add, remove, or edit a step, stage, melt curve, or data collection location.
 - Adjust the cover temperature, sample volume, or number of cycles
 - Configure VeriFlex™ Zones, ramp rate, and pause settings.
6. *(Optional)* “Define plate wells” with sample names and view Well ID, Targets, or Dyes.
7. Load a plate in the instrument (see “Load and unload a plate in the instrument” on page 36).
8. Touch **Start Run**.
When prompted, confirm that you inserted a plate.
Note: To disable this reminder, select **Do not show again** or select  **Settings** ▶ **Insert Plate Reminder** in the home screen.

Run an experiment from a saved file

In the home screen:



1. Touch  **Load Experiment**.
2. Touch  **Cloud**,  **USB**,  **My Instrument**, or  **Network Drive** to navigate to your file location.
 - For files saved to the guest profile, touch  **My Instrument** ▶ **Public**.
 - For pre and post read files, touch  **My Instrument** ▶ **Post Read**.
3. Touch the experiment file name.
4. *(Optional)* “Manage template (.edt) files” in either  **USB** or  **My Instrument**.
5. *(Optional)* “Define experiment properties”, including Run File Name (.eds file name), Plate Barcode, Reagent Information, and Data Destination.

6. (Optional) “Edit a method” on page 32.
 - Add, remove, or edit a step, stage, melt curve, or data collection location.
 - Adjust the cover temperature, sample volume, or number of cycles
 - Configure VeriFlex™ Zones, ramp rate, and pause settings.
7. (Optional) “Define plate wells” with sample names and view Well ID, Targets, or Dyes.
8. Load a plate in the instrument (see “Load and unload a plate in the instrument” on page 36).
9. Touch **Start Run**.
 When prompted, confirm that you inserted a plate.
Note: To disable this reminder, select **Do not show again** or select  **Settings** ▶ **Insert Plate Reminder** in the home screen.

Repeat your last experiment run

This feature is only applicable to runs started from the instrument and not available for runs started from the desktop software. If you are signed-in, this function applies to the last run from your profile.



In the home screen:

1. Touch  **Run Last**.
2. (Optional) “Define experiment properties”, including Run File Name (.eds file name), Plate Barcode, Reagent Information, and Data Destination.
3. (Optional) “Edit a method” on page 32.
 - Add, remove, or edit a step, stage, melt curve, or data collection location.
 - Adjust the cover temperature, sample volume, or number of cycles
 - Configure VeriFlex™ Zones, ramp rate, and pause settings.
4. (Optional) “Define plate wells” with sample names and view Well ID, Targets, or Dyes.
5. Load a plate in the instrument (see “Load and unload a plate in the instrument” on page 36).
6. Touch **Start Run**.
 When prompted, confirm that you inserted a plate.
Note: To disable this reminder, select **Do not show again** or select  **Settings** ▶ **Insert Plate Reminder** in the home screen.

Edit an experiment before starting a run

Define experiment properties

Open an experiment (see “Run an experiment from a saved file” on page 29) or template (see “Create and run an experiment from a template” on page 29) (.edt files), then touch **Properties** ▶ **Edit** to define the experiment properties.

- Edit the experiment name.
 - a. Touch the **Run File Name** text field.
 - b. Enter the run file name (.eds file), then touch **Done**.
- Add a plate barcode to your experimental record.
 - a. Touch the **Plate Barcode** text field.
 - b. Enter the **Plate Barcode**, then touch **Done**.
- Record reagents and their expiration dates.
 - a. Touch  **Reagent Information**.
 - b. Touch **Add**, or touch an existing reagent, then touch **Edit** or **Delete**.
 - c. Touch the **Name**, **Type**, **Lot #**, **Reagent Barcode**, **Part #**, or **Expiration Date** field to enter individual reagent information.
 - d. Touch **Done**.
- Automatically transfer data after a run is completed.
 - a. Touch  **Data Destination**.
 - b. Touch  to choose a data destination.
 - c. Under your desired data destination, select **Automatically transfer experiment**.
 - d. Touch **Done**.
Your selection displays on the Properties screen.
- Add a comment or tag to your experiment record.
 - a. Touch **Comments**.
 - b. Enter text, then touch **Done**.

Scan a barcode using the optional barcode scanner

The instrument is compatible with an optional Handheld Barcode Scanner (Cat. no. 448842, purchased separately). The barcode scanner reads Code 128 (alphanumeric), which supports 128 ASCII character barcodes.



WARNING! LASER. Exposure to direct or reflected laser light can burn the retina and leave permanent blind spots. Never look into the laser beam. Remove jewelry and anything else that can reflect the beam into your eyes. Protect others from exposure to the beam.

To scan a barcode using the hand-held barcode scanner:

1. Select the field in the touchscreen or software where you want to enter the barcode.
2. Hold the hand-held barcode scanner 20–30 cm away from a plate or container label and aim at the center of the barcode, then press the trigger.
3. Slowly move the scanning beam across the barcode until the scanner emits a high-pitched tone.

When the scanner scans a barcode, it automatically:

- Transmits the alphanumeric equivalent of the barcode to the touchscreen or software.
- Transmits a carriage-return character (the equivalent of pressing the Enter key).
- Transmits the reagent information for other fields (Lot #, Part #, Expiration Date, etc.)

For more information on the hand-held barcode scanner, refer to the user documentation shipped with the barcode scanner.

Edit a method

Access a method for editing.

- “Create and run an experiment from a template” on page 29.
- “Run an experiment from a saved file” on page 29.
- “Repeat your last experiment run” on page 30.

See “Method elements” on page 33 for an overview of the method as it is graphically represented in the software.

In the Method screen:

1. Touch **Edit**.
2. Touch in a field, enter any desired change, then touch **Enter**.
Note: Touch and drag  to quickly increase or decrease a step temperature.
3. Touch **Manage Steps** to add or remove a step, stage, melt curve, or data collection location.

Note: Manage Steps also provides access to the Advanced Options: **VeriFlex™ Zones, Ramp Rates, and Add Pause**.

Method elements

A method consists of one or more stages, each with one or more steps. Within each stage, the number of times the steps repeat is indicated in the Number of Cycles field. The method also specifies the sample volume and heated cover temperature.

See the figure below for a representation of method elements.

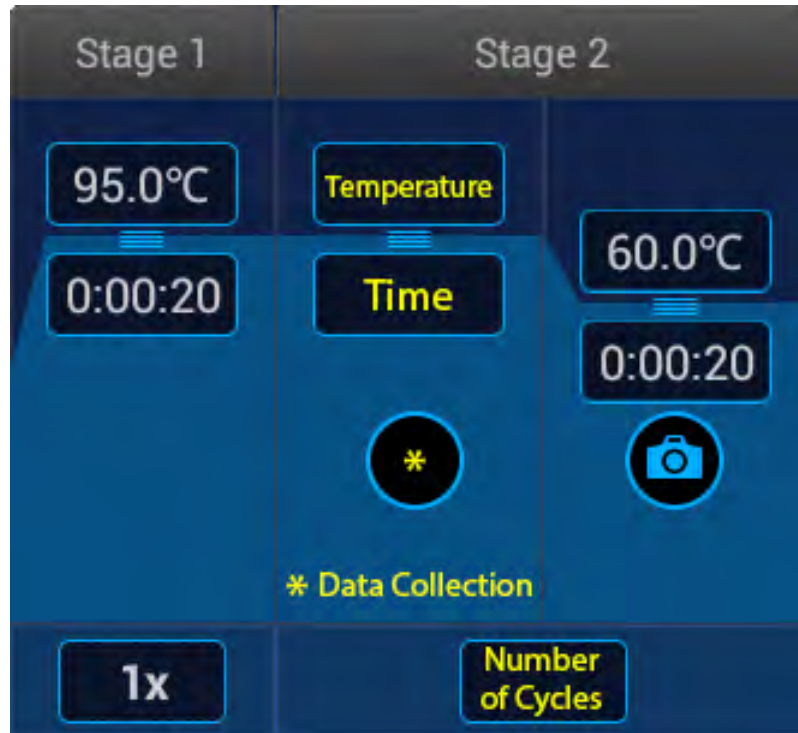

Manage Steps

In the Method screen, touch **Edit** ▶ **Manage Steps**.

Add or remove a step, stage, melt curve, or data collection point using the **Manage Steps** option. You can also access “Advanced Options” on page 34 from the Manage Steps screen.

- Add a melt curve.
 - a. Touch **Melt curves** ▶ **Add melt curve**.
 - b. Touch the **+** on the left or right border of a step to add a melt curve before or after, respectively.
 - c. Choose **Continuous** or **Step and hold**.
 - d. Touch melt curve parameters to edit if necessary, then touch **Done**.
 - e. Touch **Done**.

Depending on the experiment type, there may be restrictions on the addition of melt curves.

- Remove a melt curve.
 - a. Touch **Remove melt curve**.
 - b. Touch **—** on the melt curve to be removed.
 - c. Touch **Done**.
- Add a step.
 - a. Touch **Add/Remove steps ▶ Add steps**.
 - b. Touch the **+** on the left or right border of a step to add a step before or after, respectively.
 - c. Enter parameters for the new step, then touch **Enter**.
 - d. Touch **Done**.
- Remove a step.
 - a. Touch **Add/Remove steps ▶ Remove steps**.
 - b. Touch the **—** on any step to remove it, then touch **Done**.
- Add a stage.
 - a. Touch **Add/Remove stages ▶ Add stages**.
 - b. Touch the **+** on the left or right border of a stage to add a stage before or after, respectively.
 - c. Touch **Done**.
 - d. Edit parameters of the new stage in the Method screen (see “Edit a method” on page 32).
- Remove a stage.
 - a. Touch **Add/Remove stages ▶ Remove stages**.
 - b. Touch the **—** on any stage to remove it, then touch **Done**.
- Add or remove data collection locations.
 - a. Touch **Data collection location**.
 - b. Touch  to switch data collection on or off.

Advanced Options



In the Method screen, touch **Edit ▶ Manage Steps ▶ Advanced Options**.

- To use VeriFlex™ Zones (96-well blocks only):
 - a. Touch **VeriFlex™ Zones**.
 - b. Touch  on the step which you want to apply VeriFlex™ Zones.

- c. Touch each zone to edit the temperature, then touch **Enter**.
The background colors of VeriFlex™ Zones change with the temperature edit. Zones with higher temperatures display a background brighter than those with lower temperatures.
 - d. (Optional) Apply additional VeriFlex™ Zones.
 - e. Touch **Done**.
- To edit Ramp Rates:
 - a. Touch **Ramp Rates**.
 - b. Touch the ramp rates fields.
 - c. Touch **Enter**.
 - d. (Optional) Edit additional steps, then touch **Done**.
 - To add a pause into the method:
 - a. Touch **Add Pause**.
 - b. Touch **||** in a stage.
 - c. Enter the pause temperature, and the cycle after which you want the pause to occur.
 - d. Touch **Enter**.
The pause is represented by a **P** in the corner of the stage.
 - e. Touch **Done**.

Define plate wells

Touch the **Plate** tab of an open experiment or template file to access these functions.

Touch  to view the plate layout or  to view the well table.

In the plate layout:

1. Touch **Manage** or touch an individual well.
 - a. Touch the **Samples** tab, select one or more wells, then touch **Edit**.
 - b. Enter a sample name for the well(s) you have selected, then touch **Done**.
 - c. Touch the **Targets** tab to view the targets assigned to the wells.
 - d. In the Targets tab, touch **Details** to view target information, then touch **Done**.
2. Touch **Done** to return to the Plate tab.
3. Touch  to access the well table.
 - a. Touch **Edit** to edit sample names for individual wells.
 - b. Touch a sample name text field, enter a new name, then touch **Done**.

Load and unload a plate in the instrument



CAUTION! Use flat caps for 0.2-mL tubes and 0.1-mL tubes. Rounded caps can damage the heated cover.

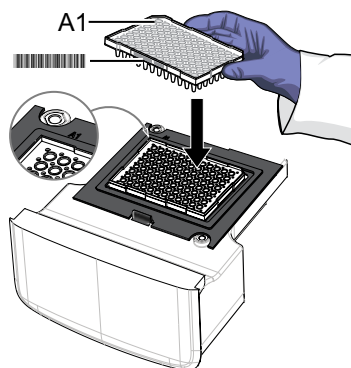

1. Load the plate.
 - a. Touch  to eject the instrument drawer.
 - b. Load the plate onto the plate adaptor so that:
 - Well A1 of the plate is in the top-left corner of the plate adaptor.
 - The barcode faces the front of the instrument.



IMPORTANT! Plates should be loaded and unloaded by trained operators who have been warned of the moving parts hazard.

Note: (For 96-well 0.2-mL blocks only) Do not remove the black plate adaptor before loading a plate or strip tubes. Strip tubes may fit loosely in the adaptor, but when the drawer closes, the heated cover will apply the appropriate pressure to seat the tube strips securely in the adaptor.

Note: The 384-well and 96-well Fast (0.1-mL) block configurations do not require a plate adapter.

- c. Touch  to close the instrument drawer.
2. Unload the plate.
 - a. Touch  to eject the instrument drawer.
 - b. Remove the plate.
 - c. Touch  to close the instrument drawer.





CAUTION! PHYSICAL INJURY HAZARD. During instrument operation, the plate temperature can reach 100°C. Allow it to cool to room temperature before handling.

Note: If the instrument does not eject the plate, contact Support.

View, pause, or stop a run

During an instrument run, you can:

- “View well details” on page 37
- “Pause or stop a run” on page 37
- “Adjust the graphical view of an experiment” on page 37
 - Touch  or swipe left once to access real-time views of the run method or to edit the number of cycles.
 - Touch  or swipe left twice to view the real-time data plot.

View well details

In the home screen, during an instrument run:

1. Touch the right arrow  or swipe left twice.
2. Touch **Well details**.
3. Touch **Samples**, **Targets**, or **Tasks** to select a graphical representation of each.
4. Touch **Close** to return to the home screen.

Pause or stop a run

In the home screen, during an instrument run:

1. Touch the right arrow  or swipe left to access real-time views of the run.
2. Stop or pause the run.
 - Touch **Stop Run**.
 - Touch **Pause**, then enter a pause temperature.





CAUTION! PHYSICAL INJURY HAZARD. During instrument operation, the plate temperature can reach 100°C. If you want to access the plate during a run pause, enter room temperature as the pause temperature and allow the plate to cool to room temperature before handling.

3. (Optional) After pausing a run, touch **Edit** to change the number of cycles.

Adjust the graphical view of an experiment

In the home screen, during an instrument run:

1. Touch the right arrow  or swipe left twice to access real-time views of the run.
2. Touch **Zoom**.
3. Touch  or  to zoom in or out.
4. Touch the arrows to pan left, right, up, or down on the graph.
5. Touch **Close** to return to the default view.

Lock the touchscreen during a run

After you have started a run, you can lock the touchscreen so that other users cannot interfere with instrument operation.

Note: You must be signed-in to use this feature.

In the home screen:



1. To lock the touchscreen:
 - a. Touch  **My Profile**.
 - b. Touch **Lock Screen**, then touch **Lock**.
2. To unlock the touchscreen:
 - a. Touch anywhere on the touchscreen.
 - b. Touch the **PIN Code** field, and enter your PIN.

Note: The touchscreen automatically unlocks when the run is complete.

Transfer, view, or manage files and results

Transfer experiment results

In the home screen, when a run is complete:

1. Touch **Transfer File**.
2. Touch  **Cloud**,  **USB**, or  **Network** to select the data destination.
3. Navigate to and select your folder destination.
4. Touch **OK**.
5. Touch **Transfer**.

“View run history” on page 38 to transfer completed run files (.eds files) at any time.

View run history



In the instrument home screen:

Touch  **Settings** ▶ **Run History**.



- Touch an individual run to view details, then touch **Delete** to delete the record, or **Transfer** to export the experiment .eds file.
- Touch **Manage** to select multiple items for simultaneous viewing, deletion, or transfer.

Guests (users not signed-in) can only view guest records. Users with instrument profiles can also view their own records. Administrators can view all experiment records.

Manage template (.edt) files

This feature applies to experiment templates (.edt files) on your  **USB** or  **My Instrument**. To manage completed run files (.eds files), see “Transfer experiment results” on page 38.

In the home screen:

1. Touch  **Load Experiment**.
2. Touch  **USB** or  **My Instrument** to select your file location and navigate to your file.
3. Touch **Manage Files**.
4. *(Optional)* Navigate through the **My Instrument**, **Public**, **USB**, and **Post Read** folders to access an .edt file. Folder availability depends on your sign-in status.
5. Touch to select one or more files.
6. Delete or copy files.
 - Touch **Delete Files** and confirm deletion.
 - Touch **Copy Files**, choose a file destination, then touch **Paste Files**.
7. Touch **Done**.



Calibrate and verify instrument performance

- Calibration and verification schedule 40
- Calibration descriptions 41
- View the calibration status and set reminders 41
- Perform ROI/Uniformity, Background, and Dye calibrations 42
- Perform instrument verification using RNase P plates 49
- Calibrate custom dyes 54
- Calibrate for a custom melt curve experiment 60

Calibration and verification schedule

The instrument is factory calibrated and does not require calibration at installation. To ensure optimal performance, perform calibrations at the recommended frequency.

Note: After instrument installation, we recommend performing instrument verification using the provided RNase P plate.

IMPORTANT! Perform calibrations and run experiments under the environmental conditions specified in “Environmental requirements” on page 95. Exposure to extreme temperatures can have adverse effects on the run results, as well as shortening the life span of the instrument components.

Calibration type	Recommended frequency
ROI/Uniformity	<ul style="list-style-type: none"> • Every two years (recommended) <p>Note: Set the calibration interval for your instrument: Settings ▶ Maintenance and Service ▶ Calibrations ▶ History and Reminders ▶ Edit ▶ Exp interval field.</p>
Dye	
Background	
RNase P instrument verification	<ul style="list-style-type: none"> • After installing or moving the instrument • As needed thereafter to confirm instrument performance

Note: For preparing custom dye plates and performing custom calibrations, see “Calibrate custom dyes” on page 54.

Calibration descriptions

Calibration type	Purpose	Description	Pass criteria
ROI/Uniformity	The software uses calibration data to map the increase in fluorescence to the plate wells during subsequent runs and to evaluate well-to-well consistency of the signals.	The software captures a plate image for each optical filter.	<ul style="list-style-type: none"> The image for each filter distinguishes all wells of the plate. Each well in the image must be distinct and visible at the same luminosity relative to the other wells in the image.
Background	The software uses calibration data to remove background fluorescence during a run. Note: You can also run this calibration to determine if contamination is related to the sample block or the plate.	The software captures a background image for each optical filter in the absence of sample and reagent, and compares the fluorescence from each well to the average for the plate.	The plate images for all filters are free of abnormal fluorescence.
Dye	The software uses calibration data to characterize and distinguish the individual contribution of each dye in the total fluorescence signals collected by the instrument.	The software extracts a spectral profile for each dye standard, then produces a set of spectral profiles plotted as fluorescence vs filter.	<ul style="list-style-type: none"> Dye spectra peak within the same filter as their group. Dye spectra can diverge slightly at other wavelengths.



View the calibration status and set reminders

View calibration status and set reminders in the instrument

Note: The calibration reminders feature requires a connection between the instrument and a computer network.

In the home screen:

1. Touch  **Settings** ▶ **Maintenance and Service** ▶ **Calibrations** ▶ **History and Reminders**.
2. In the Calibration Reminders screen, view the status of each calibration type.
3. *(Optional)* Touch a calibration row to view the history of that specific calibration type, then touch **Done**.
4. Touch **Edit** to configure the calibration reminder settings. For each calibration type:
 - a. Slide the control **On** or **Off** to enable or disable the calibration reminder.
 - b. Touch the **Exp interval** and **Remind me** text fields to set the calibration time tables.

- c. Touch **Save** to save the settings or **Cancel** to exit the screen without saving.
5. (Optional) Touch **Export** to transfer the calibration report to a  Cloud account,  USB, or  Network drive.
6. Touch **Done** to return to the Calibrations screen.

View calibration status and set reminders in the Cloud

Note: The calibration reminders feature requires a connection between the instrument and a computer network.

1. In the Thermo Fisher Cloud, click  for the Instrument Connect page.
2. Select any of your registered instruments.
3. In the Summary tab:
 - Click **+ Calibrations** to view the status of each calibration type.
 - (Optional) Click **+ Calibration Reminders** to set the calibration reminder time table and enter the notification email address(es).

Note: More than one email address can receive the calibration reminders.

Note: The settings are automatically saved.
 - (Optional) In the Downloads section, click **Maintenance Summary.pdf** to download the calibration status report.
4. In the Calibrations History tab:
 - View the history of each calibration type.
 - (Optional) Click  to download the calibration history report.

Perform ROI/Uniformity, Background, and Dye calibrations

Workflow: Calibration

If you start an ROI/Uniformity calibration, the instrument automatically prompts for calibrations to be performed in this order.

Perform an ROI/Uniformity calibration

(Always followed by the other calibrations below.)



Perform a Background calibration

(Perform any time that the ROI/Uniformity calibration is current.)



Perform Dye calibrations

(Perform any time that the ROI/Uniformity and Background calibrations are current.)

Prepare a calibration plate

Materials required for calibration plate preparation

- Plate(s) for the calibration you are performing:
 - ROI/Uniformity plate (one ROI plate needed)
 - Background calibration plate
 - Dye calibration plates

Note: We recommend calibrating with all Spectral Dye Calibrations Plates available for your block configuration even if you are not using all the dyes in the plates.

Note: Do not discard the packaging for the calibration plates. Each calibration plate can be used up to 3 times if the plate is:

- Stored in its packing sleeve at -15 to -25°C
- Used within 6 months after opening
- Used before the plate's expiry date
- Centrifuge with plate adapter; buckets cleaned before use
- Powder-free gloves
- Safety glasses

Thaw, vortex, and centrifuge a calibration plate

1. Remove the calibration plate from the freezer, then thaw the plate in its packaging. Keep plates protected from light until you perform the calibration.
 - Thaw each plate for 30 minutes.
 - Use each plate within 2 hours of thawing.

IMPORTANT! Do not remove the plate from its packaging until you are ready to use it. The fluorescent dyes in the wells of calibration plates are photosensitive. Prolonged exposure to light can diminish the fluorescence of the dyes.

2. While wearing powder-free gloves, remove the calibration plate from its packaging and retain the packaging. Do not remove the optical film.
3. Vortex the plate for 5 seconds, then centrifuge for 2 minutes at 750 to $1000 \times g$.
4. Confirm that the liquid in each well is at the bottom of the well and free of bubbles. If it is not, centrifuge the plate again.

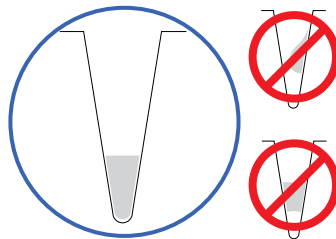

IMPORTANT! Keep the bottom of the plate clean. Fluids and other contaminants on the bottom of the plate can contaminate the sample block and cause an abnormally high background signal.

Perform calibrations

1. In the home screen:

Calibration type	Touch
ROI/Uniformity ^[1]	⚙️ Settings ▶ Maintenance and Service ▶ Calibrations ▶ ROI and Uniformity
Background	⚙️ Settings ▶ Maintenance and Service ▶ Calibrations ▶ Custom ▶ Background
Dye	⚙️ Settings ▶ Maintenance and Service ▶ Calibrations ▶ Dye

^[1] Automatically followed by Background and Dye calibrations.

2. Follow the instructions on the screen to start the calibration.

Note: *Dye calibration only:* Select the Dye Plate to run, then touch **Next**.

3. Load the plate.

- a. Touch  to eject the instrument drawer.
- b. Load the plate onto the plate adaptor so that:
 - Well A1 of the plate is in the top-left corner of the plate adaptor.
 - The barcode faces the front of the instrument.

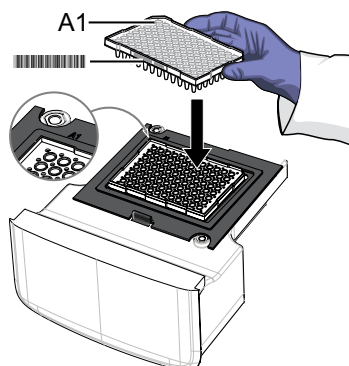

IMPORTANT! Plates should be loaded and unloaded by trained operators who have been warned of the moving parts hazard.

Note: (For 96-well 0.2-mL blocks only) Do not remove the black plate adapter before loading a plate or strip tubes. Strip tubes may fit loosely in the adapter, but when the drawer closes, the heated cover will apply the appropriate pressure to seat the tube strips securely in the adapter.

Note: The 384-well and 96-well Fast (0.1-mL) block configurations do not require a plate adapter.



- c. Touch  to close the instrument drawer.

4. Touch **Start**.

5. When the run is complete and the screen displays Calibration Complete, touch **View Results** to check the calibration status.

Calibration status	Action
Passed	Touch Next to proceed to the next required calibration.
Failed	See “Troubleshoot calibration failure” on page 47.

Note: You can view the calibration images only after the ROI/Uniformity and Background calibrations pass.

6. Unload the plate.
- Touch  to eject the instrument drawer.
 - Remove the plate.
 - Touch  to close the instrument drawer.



CAUTION! PHYSICAL INJURY HAZARD. During instrument operation, the plate temperature can reach 100°C. Allow it to cool to room temperature before handling.

Note: If the instrument does not eject the plate, contact Support.

7. Return the plate to its original packaging.

Note: Each calibration plate can be used up to 3 times if the plate is:

- Stored in its packing sleeve at -15 to -25°C
- Used within 6 months after opening
- Used before the plate's expiry date

View calibration images and transfer results to USB

The instrument performs the ROI, Uniformity, and Background calibrations in sequence. You can view the calibration images after the Background calibration is complete.

1. In the Calibration Status screen, touch **Details**.
2. In the Details screen, touch a calibration type to view its images and plots.

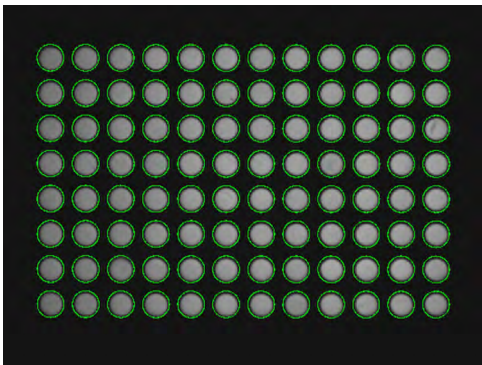
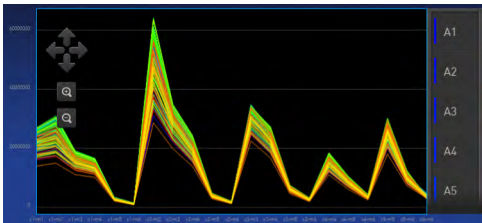
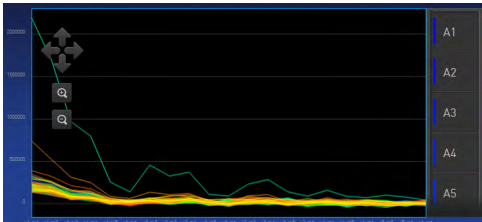
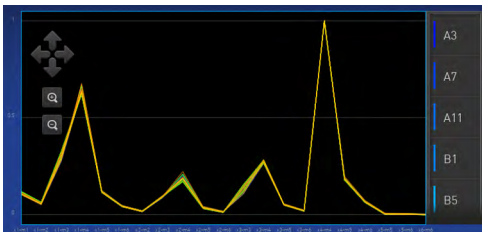
Calibration	Example results indicating successful calibration
ROI Note: Select the desired filter combination from the Filter Set drop-down list.	Green circles around all wells and bright well centers. 
Uniformity	Signals from each well following a uniform trend. 
Background	Few, if any, signals with abnormally high fluorescence. 
Dye	Signals from each well following a uniform trend. 

3. In the Calibration Status screen:
 - a. Touch **Accept Results** or **Reject Results**.
 Accepting the results saves the calibration data to the instrument and overwrites existing data.
 - b. (Optional) Touch **Transfer EDS** to transfer the calibration data to a USB.

Troubleshoot calibration failure

Observation	Possible cause	Recommended action
Calibration failed	The plate was improperly prepared.	Ensure the following: <ul style="list-style-type: none"> • The correct plate was used for the calibration performed. • The plate was properly thawed. • The plate was properly spun down. • The heat seal of the plate was properly sealed.
	The plate is damaged or contaminated.	Check for damage, improper heat seal, or contamination.
		Order a replacement plate. If the replacement plate fails, contact Support.
High fluorescent signal	Signals that exceed the limit of normal fluorescence may indicate fluorescent contaminants on the plate or the sample block.	See "Identify contamination" on page 47.
Calibration failed but plate is undamaged	The incorrect plate was used for calibration performed.	Use the plate that matches the calibration performed.
	The plate was improperly prepared.	Repeat the calibration with the plate properly prepared.
		If the calibration fails again, order a replacement plate. If the replacement plate fails, contact Support.

Identify contamination

Signals that exceed the limit of normal fluorescence may indicate fluorescent contaminants on the calibration plate or the sample block. Common contaminants include ink residue from permanent pens, powder from disposable gloves, and dust.

To identify and resolve a possible contamination problem:

1. View the calibration data and note the wells that failed the quality check.
2. Remove the plate from the instrument, rotate the plate 180°, then perform the calibration again.

3. Determine the location of the failed wells again as in step 1.

If the position(s) of the failed well(s) are...	Action
Identical	The sample block is contaminated. Decontaminate the sample block (see “Decontaminate the sample block” on page 63).
Reversed	The plate is contaminated. Discard the plate, then perform the calibration using a new calibration plate.

4. If the calibration fails after you decontaminate the sample block and replace the plate, contact Support.

Create a background plate (optional)

Whenever possible, use a background plate listed in Appendix C, “Parts and materials”. These plates contain a buffer that accurately simulates the reagents used for PCR, and, therefore, produces high-quality calibration data.

If a background plate is not available, you can create one as described below.

Required materials

- MicroAmp™ optical 96-well reaction plate
- Optical adhesive cover or optical flat caps
- Pipettor, 200- μ L (with pipette tips)
- Powder-free gloves
- Safety glasses
- Deionized water

IMPORTANT! Wear powder-free gloves while creating the background plate.

1. Remove a reaction plate from its box and place it on a clean, dry surface.
2. Aliquot the appropriate volume of deionized water to each well of the reaction plate.
Recommended volume for a 96-well plate is 10–20 μ L per well.
3. Seal the plate using an optical adhesive cover or optical flat caps.
4. Use the plate for background calibration as you would a background plate from the spectral calibration kit.

Perform instrument verification using RNase P plates

Instruments are factory calibrated, so calibration is not necessary for initial installation. However, we recommend that you verify the instrument performance before using the instrument.

After future calibrations, we highly recommend verifying the instrument performance. The instrument must have valid ROI/Uniformity, Background, and Dye calibrations to perform instrument verification.

Instrument verification description and schedule

Purpose	Description	Pass criteria	Frequency
Confirms the performance of the instrument.	Quantifies the number of copies of the human RNase P gene in samples with known concentrations of the corresponding DNA template.	$[(C_{TA}) - 3(\sigma_{CTA})] > [(C_{TB}) + 3(\sigma_{CTB})]$ where: <ul style="list-style-type: none"> C_{TA} = Average C_T of unknown population A σ_{CTA} = Standard deviation of unknown population A C_{TB} = Average C_T of unknown population B σ_{CTB} = Standard deviation of unknown population B The instrument successfully distinguishes between unknown populations A and B with a statistical confidence level of 99.7%	<ul style="list-style-type: none"> After installing or moving the instrument As needed to confirm instrument performance

RNase P Instrument Verification Plates

The RNase P plate contains the reagents necessary for the detection and quantitation of genomic copies of the human RNase P gene (a single-copy gene encoding the RNase moiety of the RNase P enzyme). Each well contains: PCR master mix, RNase P primers, FAM™ dye-labeled probe, and a known concentration of human genomic DNA template.

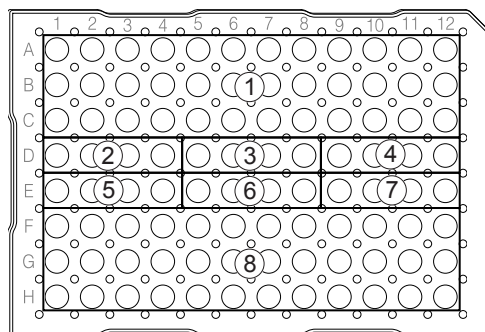

Figure 1 96-Well RNase P plate

- | | |
|-----------------------------|---------------------|
| ① Unknown A (5000) | ⑤ STD 5000 copies |
| ② NTC (no template control) | ⑥ STD 10000 copies |
| ③ STD 1250 copies | ⑦ STD 20000 copies |
| ④ STD 2500 copies | ⑧ Unknown B (10000) |

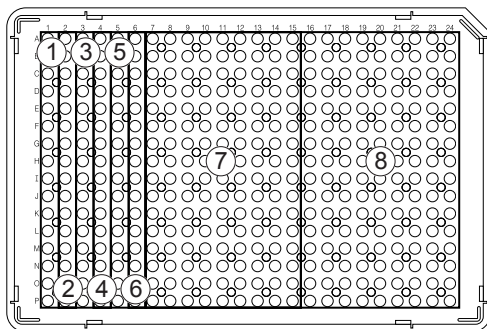

Figure 2 384-Well RNase P plate

- | | |
|-----------------------------|---------------------|
| ① NTC (no template control) | ⑤ STD 10000 copies |
| ② STD 1250 copies | ⑥ STD 10000 copies |
| ③ STD 2500 copies | ⑦ Unknown A (5000) |
| ④ STD 5000 copies | ⑧ Unknown B (10000) |

Analytical performance

After the run, the software calculates average copy number values and standard deviation values. The instrument passes verification if the following inequality is true:

$$[(C_{TA}) - 3(\sigma_{CTA})] > [(C_{TB}) + 3(\sigma_{CTB})]$$

where:

- C_{TA} = Average C_T of unknown population A
- σ_{CTA} = Standard deviation of unknown population A
- C_{TB} = Average C_T of unknown population B
- σ_{CTB} = Standard deviation of unknown population B

Installation specification

The instrument passes the installation specification if the inequality holds and the instrument successfully distinguishes between unknown populations A and B with a statistical confidence level of 99.7%.

The software automatically adjusts the threshold and omits a defined number of wells from the unknown populations to meet the installation specifications. To view any of the omitted well(s), open the verification file in the desktop software or cloud software.

Prepare an RNase P plate

Materials required for RNase P plate preparation

- RNase P instrument verification plate
- Centrifuge with plate adapter; buckets cleaned before use
- Powder-free gloves
- Safety glasses

Thaw, vortex, and centrifuge an RNase P plate

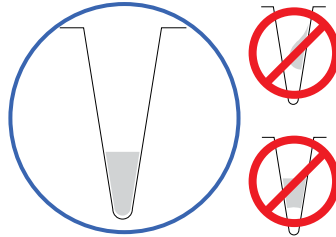

1. Remove the RNase P plate from the freezer, then thaw the plate in its packaging.
 - Thaw the plate for approximately 5 minutes.
 - Use the plate within 30 minutes of thawing.
2. While wearing powder-free gloves, remove the plate from its packaging.

3. Vortex the plate for 5 seconds, then centrifuge for 2 minutes at 750 to 1000 × g.
4. Confirm that the liquid in each well is at the bottom of the well and free of bubbles. If it is not, centrifuge the plate again.



IMPORTANT! Keep the bottom of the plate clean. Fluids and other contaminants on the bottom of the plate can contaminate the sample block and cause an abnormally high background signal.

Perform RNase P verification

1. In the home screen, touch  **Settings** ▶ **Maintenance and Service** ▶ **RNase P Verification**.
2. Load the plate.
 - a. Touch  to eject the instrument drawer.
 - b. Load the plate onto the plate adaptor so that:
 - Well A1 of the plate is in the top-left corner of the plate adaptor.
 - The barcode faces the front of the instrument.

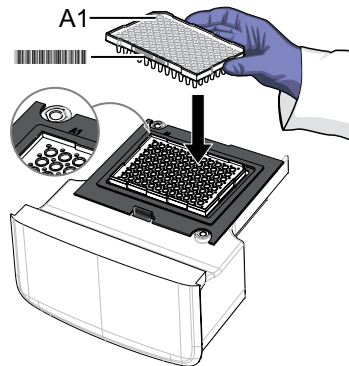

IMPORTANT! Plates should be loaded and unloaded by trained operators who have been warned of the moving parts hazard.



Note: (For 96-well 0.2-mL blocks only) Do not remove the black plate adapter before loading a plate or strip tubes. Strip tubes may fit loosely in the adapter, but when the drawer closes, the heated cover will apply the appropriate pressure to seat the tube strips securely in the adapter.

Note: The 384-well and 96-well Fast (0.1-mL) block configurations do not require a plate adapter.

- c. Touch  to close the instrument drawer.

3. Touch **Start**.
4. When the run is complete and the screen displays Verification Complete, touch **View Results** to confirm the status of the run.

Calibration status	Action
Passed	Instrument is ready for use.
Failed	See "Troubleshoot verification failure" on page 53.

5. In the RNase P Verification Status screen, touch:
 - **Accept Results** to save the results to the instrument
 - **Reject Results** to delete the RNase P verification results
 - **Export Results** to export the calibration results to a USB
6. Unload the plate.
 - a. Touch  to eject the instrument drawer.
 - b. Remove the plate.
 - c. Touch  to close the instrument drawer.



CAUTION! PHYSICAL INJURY HAZARD. During instrument operation, the plate temperature can reach 100°C. Allow it to cool to room temperature before handling.

Note: If the instrument does not eject the plate, contact Support.

Troubleshoot verification failure

Observation	Possible cause	Recommended action
Verification failed	The plate was improperly prepared.	Ensure the following: <ul style="list-style-type: none"> • The correct plate was used for the verification performed. • The plate was properly thawed. • The plate was properly spun down. • The heat seal of the plate was properly sealed.
		Open the verification file in the desktop software or cloud software to view the flags and troubleshooting details for failed wells.
	The plate is damaged or contaminated.	Check for damage, improper heat seal, or contamination.
		Order a replacement plate. If the replacement plate fails, contact Support.
High fluorescent signal	Signals that exceed the limit of normal fluorescence may indicate fluorescent contaminants on the plate or the sample block.	See "Identify contamination" on page 47.
Verification failed but plate is undamaged	The incorrect plate was used for verification.	Use the correct RNase P plate for verification.
	The plate was improperly prepared.	Repeat the verification with a new properly prepared plate. Note: The verification procedure is an experiment run, so each RNase P plate can only be used once.
		Open the verification file in the desktop software or cloud software to view the flags and troubleshooting details for failed wells.
		If the verification fails again, order a replacement plate. If the replacement plate fails, contact Support.

Calibrate custom dyes

Custom dyes overview

The QuantStudio™ 3 and 5 Real-Time PCR Systems can be used to run assays designed with custom dyes (dyes not manufactured by Thermo Fisher Scientific or dyes not pre-calibrated with the instrument). Custom dyes must excite between 455–672 nm and emit between 505–723 nm.

Custom dye calibration

For each custom dye, determine the optimal dye concentration. Use this concentration for preparing all subsequent dye calibration plates.

Dilute the custom dye to an optimal concentration

Prepare a custom dye dilution plate



Run the dilution plate as an experiment



Determine the optimal dye concentration



Calibrate the custom dye for each plate

Create a custom dye calibration plate



Add a custom dye to the software



Perform a custom dye calibration

Dilute the custom dye to an optimal concentration

Custom dye dilution guidelines

Prepare a dilution series for each custom dye.

- Target several dye concentrations within a range of 100–2000 nM.
- Choose a 2- or 3-fold difference in dilution points.
- Dispense 10–20 μ L per well for 96-well plates or 5 μ L per well for 384-well plates.
- Dilute the dye in buffer compatible with your master mix.
- (*Intercalating dyes only*) Add the appropriate amount of amplified PCR product to generate fluorescence.

Prepare a custom dye dilution plate

IMPORTANT! Wear powder-free gloves throughout the procedure.

1. Prepare a 2 or 3-fold dilution series of the custom dye.
2. Dispense aliquots of each dilution into the center of a reaction plate, then seal the plate.

A full plate is not needed. See the figures below for suggested replicates.

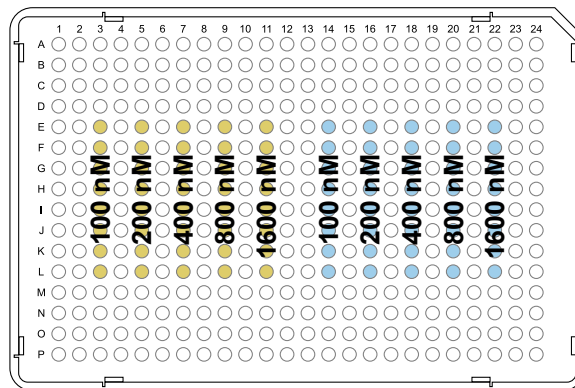
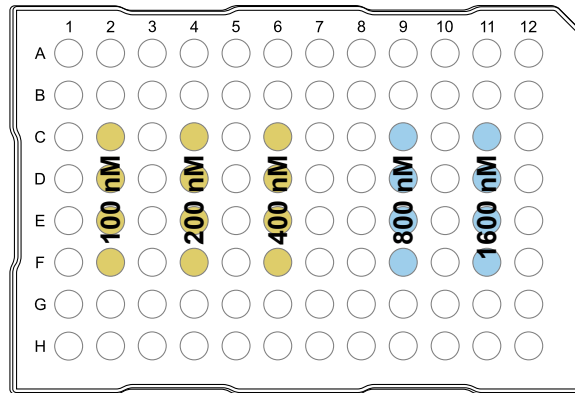

3. Vortex the plate for 5 seconds, then centrifuge for 2 minutes at 750 to 1000 × g.
4. Confirm that the liquid in each well is at the bottom of the well and free of bubbles. If it is not, centrifuge the plate again.

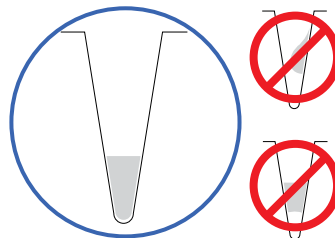

IMPORTANT! Keep the bottom of the plate clean. Fluids and other contaminants on the bottom of the plate can contaminate the sample block and cause an abnormally high background signal.

Run the dilution plate as an experiment

1. Load the plate into the instrument.
2. Set up a genotyping experiment on the instrument.
 - Load an experiment created in either the desktop or cloud software.
 - a. In the home screen, touch **Load Experiment**.
 - b. Select the experiment location, then the experiment file.
 - Create a new experiment on the instrument touchscreen.
 - a. In the home screen, touch **Open Template ▶ Genotyping ▶ Genotyping Post**.
 - b. *(Optional)* In the Properties tab, edit the experiment properties.
 - c. In the Method tab, set the hold temperature to 60°C with a 2 minute hold and enter the appropriate reaction volume.
 - d. In the Plate tab, enter the dilution series information for the appropriate wells.
3. Touch **Start Run**.
4. When the run is complete, download the results for analysis.
5. Unload the plate from the instrument.



CAUTION! PHYSICAL INJURY HAZARD. During instrument operation, the plate temperature can reach 100°C. Allow it to cool to room temperature before handling.

Determine the optimal dye concentration

Review the dye signal data and select the dilution to calibrate.

1. In the **Results** tab of either the desktop or cloud software, select **Raw Data Plot**.

This plot displays the raw fluorescent signal of each dye, for individual wells and at individual cycles over the duration of the PCR run.

Note: The Raw Data Plot is not available for viewing on the instrument touchscreen.
2. For each replicate population of dilutions, select the wells in the Plate Layout tab to view in the plot.

- Examine the raw data and identify the well(s) yielding signals according to the ranges shown in the following table.

Plate type	Acceptable signal range
96-well	800,000 to 3,200,000
384-well	400,000 to 2,000,00

Note: You can also export the raw data and average for the various concentrations.

- Select the lowest (optimal) dye concentration that falls within the acceptable signal range.

Calibrate the custom dye

Create a custom dye calibration plate

IMPORTANT! Wear powder-free gloves while creating the dye plate.

Create a full plate of the custom dye diluted to the optimal concentration:

- Dilute the custom dye to the optimal concentration in buffer. Prepare an adequate volume, using a recommended volume range of 10–20 μL /well for a 96-well plate.
- Pipet the appropriate volume of the diluted custom dye to all wells of an optical reaction plate.
- Seal the plate.
- Vortex the plate for 5 seconds, then centrifuge for 2 minutes at 750 to 1000 \times g.
- Confirm that the liquid in each well is at the bottom of the well and free of bubbles. If it is not, centrifuge the plate again.

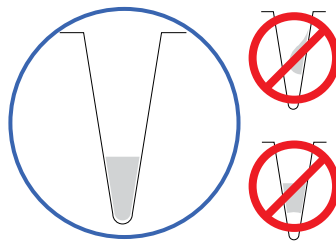

IMPORTANT! Keep the bottom of the plate clean. Fluids and other contaminants on the bottom of the plate can contaminate the sample block and cause an abnormally high background signal.

Add a custom dye to the software

- In the home screen, touch  **Settings** \blacktriangleright **Maintenance and Service** \blacktriangleright **Calibrations** \blacktriangleright **Custom** \blacktriangleright **Custom Dye**.
- Touch **Add Custom Dye** to enter information about the new custom dye.

3. Enter the dye information:

Field/option	Action
Custom Dye Name	Enter a name for the custom dye. IMPORTANT! <ul style="list-style-type: none"> • Do not use a system dye name for a custom dye name. • Dye names are case and spacing sensitive.
Type	Select: <ul style="list-style-type: none"> • Reporter – The dye works in conjunction with a quencher dye to report an increase of PCR product. • Quencher – The dye suppresses the fluorescence of a reporter dye until amplification of PCR product. • Both – The dye reports an increase of PCR product without the aid of a quencher dye.

4. Touch **Save** to add the custom dye or **Cancel** to exit the screen without saving the new dye details.

Note: You must add the custom dye to the desktop or cloud software dye libraries before creating, running, or analyzing experiments that use custom dyes. Refer to the *QuantStudio™ Design and Analysis desktop Software User Guide* (Pub. no. MAN0010408) or the *QuantStudio™ Design and Analysis cloud Software Help* (Pub. no. MAN0010414).

Perform a custom dye calibration

IMPORTANT! If you added a custom dye to the dye library in the desktop software or cloud software, you will need to re-enter the custom dye information in the instrument touchscreen before you perform the custom dye calibration (see “Add a custom dye to the software” on page 57).

1. Load the plate (see “Load and unload a plate in the instrument” on page 36).
2. In the home screen, touch  **Settings** ▶ **Maintenance and Service** ▶ **Calibrations** ▶ **Custom** ▶ **Custom Dye**.
3. Touch the custom dye you wish to calibrate.
4. Review the custom dye information, make changes as necessary, then touch **Update**.
5. Enter the calibration temperature.
6. (Optional) Touch **Reagents**, then enter reagent information.
7. Touch **Start**.
8. When the run is complete and the screen displays Calibration Complete, touch **View Results** ▶ **Details**.

9. Review the plot. Passing calibration results show uniform signals with peaks aligned with the dye's wavelength.

Peak channel	Filter wavelength (nm) ^[1]	
	Excitation	Emission
x1-m1	470 ± 15	520 ± 15
x2-m2	520 ± 10	558 ± 12
x3-m3	550 ± 10	587 ± 10
x4-m4	580 ± 10	623 ± 14
x5-m5	640 ± 10	682 ± 14
x6-m6	662 ± 10	711 ± 12

^[1] The central wavelengths are the optimized wavelengths.

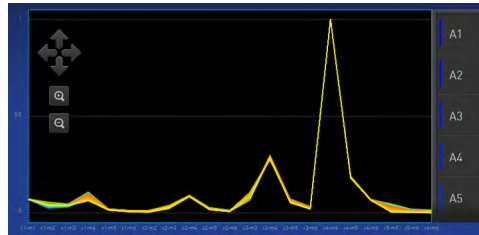

Note: Example dye calibration plot.
 The peaks for your dye may align with a different filter set.

10. Select an action depending on whether the custom dye calibration passed or failed.

Calibration status	Action
Passed	<ul style="list-style-type: none"> Touch Accept Results or Reject Results. <p>Note: Accepting the results saves the calibration data to the instrument and overwrites existing data.</p> <ul style="list-style-type: none"> <i>[Optional]</i> Touch Transfer EDS to transfer the calibration data to a USB.
Failed	<ul style="list-style-type: none"> Create another custom dye plate using the next dye concentration greater than the concentration determined in "Determine the optimal dye concentration", then perform the calibration again. See "Troubleshoot calibration failure" on page 47.

11. Unload the plate (see "Load and unload a plate in the instrument" on page 36).

Calibrate for a custom melt curve experiment

Note: A custom melt calibration calibrates a custom dye and a melt calibration at the same time.

Before running the custom melt calibration:

- Ensure that all calibrations are current (touch  **Settings** ▶ **Maintenance and Service** ▶ **Calibrations** ▶ **History and Reminders**).
- “Add a custom dye to the software” on page 57.

In the home screen:

1. Touch  **Settings** ▶ **Maintenance and Service** ▶ **Calibrations** ▶ **Custom** ▶ **Custom Melt**.
2. Touch **PCR + Melt** or **Melt only** as appropriate for the kit you are using.
3. Load the plate (see “Load and unload a plate in the instrument” on page 36).
4. Select or add a dye, then select a filter set appropriate for your dye's wavelength (see filter-wavelength table below).

Note: Refer to your reagent kit documentation for dye name and wavelength information.

Peak channel	Filter wavelength (nm) ^[1]	
	Excitation	Emission
x1-m1	470 ± 15	520 ± 15
x2-m2	520 ± 10	558 ± 12
x3-m3	550 ± 10	587 ± 10
x4-m4	580 ± 10	623 ± 14
x5-m5	640 ± 10	682 ± 14
x6-m6	662 ± 10	711 ± 12

^[1] The central wavelengths are the optimized wavelengths.

IMPORTANT! If the selected filter set does not match your reagent kit documentation, then the incorrect wavelength may be collected during a run.

5. (Optional) Touch **Reagents**, then enter reagent information.
6. Touch **Start**.
7. When the run is complete and the screen displays Calibration Complete, touch **View Results** ▶ **Details**.

- Review the plot. Passing calibration results show uniform signals with peaks aligned with the dye's wavelength.

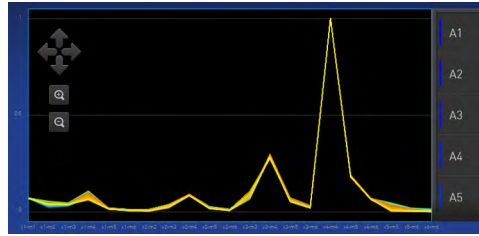

Note: Example dye calibration plot.
 The peaks for your dye may align with a different filter set.

- Select an action depending on whether the custom dye calibration passed or failed.

Calibration status	Action
Passed	<ul style="list-style-type: none"> Touch Accept Results or Reject Results. <p>Note: Accepting the results saves the calibration data to the instrument and overwrites existing data.</p> <ul style="list-style-type: none"> { <i>Optional</i> } Touch Transfer EDS to transfer the calibration data to a USB.
Failed	<ul style="list-style-type: none"> Create another custom dye plate using the next dye concentration greater than the concentration determined in "Determine the optimal dye concentration", then perform the calibration again. See "Troubleshoot calibration failure" on page 47.

- Unload the plate (see "Load and unload a plate in the instrument" on page 36).

Note: You must add the custom dye to the desktop or cloud software dye libraries before creating, running, or analyzing experiments that use custom dyes. Refer to the *QuantStudio™ Design and Analysis desktop Software User Guide* (Pub. no. MAN0010408) or the *QuantStudio™ Design and Analysis cloud Software Help* (Pub. no. MAN0010414).

Note: To perform a custom melt experiment, you can either create a Standard Curve or a Custom experiment with melt, then specify the data points per degree in the method.

5

Maintain the instrument





- Backup or restore the instrument 62
- Decontaminate the sample block 63
- Replace the instrument fuses 65
- Power on or off, store, and move 66

IMPORTANT! This chapter contains user maintenance procedures for the instrument. Procedures other than those described in this document must be performed by a qualified Service Engineer.

Backup or restore the instrument

In the home screen:

Touch  **Settings** ▶ **Maintenance and Service** ▶ **Backup/Restore**.

To	Action
Backup	<ol style="list-style-type: none"> 1. Touch Backup Instrument. 2. Touch  USB or  Cloud to choose where to backup your instrument. 3. Enter a backup file name, then touch Done. 4. Select which elements you will backup, or leave them all selected. 5. Touch Backup.
Restore (Administrator only)	<ol style="list-style-type: none"> 1. Touch Restore a Backup. 2. Touch  USB or  Cloud to select where you will restore from. 3. Select your backup file, then touch Restore.

Decontaminate the sample block

Perform this procedure to eliminate fluorescent contaminants from the instrument sample block. Contamination is generally evident in failed background calibrations where one or more wells consistently exhibit abnormally high signals.



CAUTION! PHYSICAL INJURY HAZARD. Do not remove the instrument cover. There are no components inside the instrument that you can safely service yourself. If you suspect a problem, contact Support.



CAUTION! PHYSICAL INJURY HAZARD. During instrument operation, the sample block temperature can reach 100°C. Allow it to cool to room temperature before handling.



CAUTION! Before using a cleaning or decontamination method other than those recommended by Thermo Fisher Scientific, confirm with Thermo Fisher Scientific that the proposed method will not damage the equipment.

Materials required

- Safety glasses
- Powder-free gloves
- Tissue, lint-free
- Cotton or nylon swabs and lint-free cloths
- Pipette (100- μ L) with pipette tips
- Deionized water
- Ethanol, 95% solution
- Bleach, 10% solution

Clean the sample block



CAUTION! PHYSICAL INJURY HAZARD. During instrument operation, the sample block temperature can reach 100°C. Allow it to cool to room temperature before handling.

IMPORTANT! Wear powder-free gloves when you perform this procedure.

1. Identify the contaminated wells of the sample block (see “Identify contamination” on page 47).
2. Prepare the instrument and access the sample block:
 - a. Power off and unplug the instrument, then allow it to cool for 15 minutes.
 - b. Pull the instrument drawer forward to expose the sample block.

3. Rinse the contaminated wells of the sample block with deionized water (see “Solvents for cleaning the sample block” on page 65).

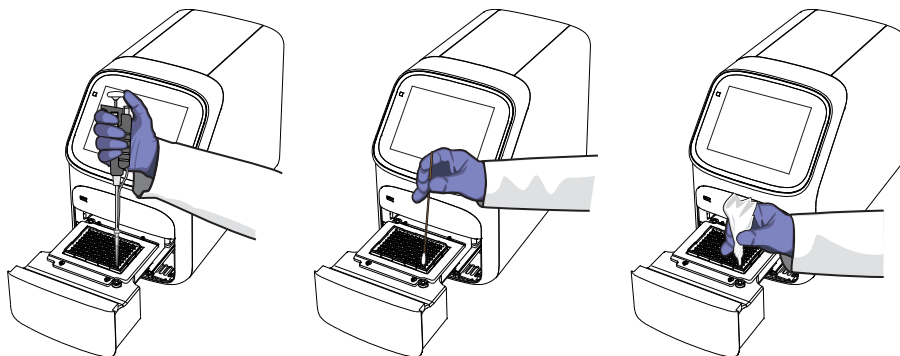

4. Close the drawer and test the block for contamination:
 - a. Push the instrument drawer back in to the instrument.
 - b. Plug in, then power on the instrument.
 - c. Perform a background calibration to confirm that you have eliminated the contamination.
5. If the contamination remains:
 - a. Repeat step 2 – step 3.
 - b. Clean the contaminated wells of the sample block using a 95% ethanol solution (see “Solvents for cleaning the sample block” on page 65).
 - c. Repeat step 3 – step 4 to rinse the sample block and to confirm that you have eliminated the contamination.

IMPORTANT! Always use deionized water to rinse wells after cleaning with bleach or ethanol solution.

6. If the contamination still remains:
 - a. Repeat step 2 – step 3.
 - b. Clean the contaminated wells of the sample block using a 10% bleach solution (see “Solvents for cleaning the sample block” on page 65).
 - c. Repeat step 3 – step 4 to rinse the sample block and to confirm that you have eliminated the contamination.

IMPORTANT! Always use deionized water to rinse wells after cleaning with bleach or ethanol solution.

7. If the contamination continues to remain, contact Support.

Solvents for cleaning the sample block

IMPORTANT! Use these solvent cleaning procedures *only* in conjunction with the "Clean the sample block" procedures.

Rinse the sample block with deionized water

1. Pipet a small volume of deionized water into each contaminated well.
2. In each well, pipet the water up and down several times to rinse the well.
3. Pipet the water to a waste beaker.
4. Use a cotton swab to scrub inside of each contaminated well.
5. Use a lint-free cloth to absorb the excess deionized water.

Clean the sample block with 95% ethanol

1. Pipet a small volume of 95% ethanol solution into each contaminated well.
2. In each well, pipet the solution up and down several times to rinse the well.
3. Pipet the ethanol solution to a waste beaker.

IMPORTANT! Always use deionized water to rinse wells after cleaning with bleach or ethanol solution.

Clean the sample block with 10% bleach

1. Pipet a small volume of 10% bleach solution into each contaminated well.
2. In each well, pipet the solution up and down several times to rinse the well.
3. Pipet the bleach solution to a waste beaker.

IMPORTANT! Always use deionized water to rinse wells after cleaning with bleach or ethanol solution.

Replace the instrument fuses



CAUTION! FIRE HAZARD. For continued protection against the risk of fire, replace fuses only with listed and certified fuses of the same type and rating as those currently in the instrument.

Materials required



- Fuses (2) – 10A, Time-Lag T, 250VAC, 5 × 20mm
- Safety glasses
- Powder-free gloves
- Screwdriver, flathead

Replace the fuses

1. Power off and unplug the instrument, then allow it to cool for 15 minutes.
2. Using a flat-head screwdriver, unscrew and remove the fuse holder.



3. Remove each fuse from its fuse holder and inspect it for damage. Carbon typically coats the inside of failed fuses.

Good	Failed
	

4. Replace each failed fuse.

Note: The voltage and amperage ratings are on the fuse holder.
5. Install the fuse holder back into the instrument.
6. Plug in, then power on the instrument.

The installation is successful if the instrument powers on.

Note: Fuse failure can result from fluctuations in the supplied power to the system. To prevent further failures, consider installing an electrical protective device, such as a UPS or a surge protector. If issues with the fuse persist, contact Support.

Power on or off, store, and move

Enable sleep mode

In the home screen:

1. Touch  **Settings** ▶ **Instrument Settings** ▶ **Sleep Mode**.
2. Slide the control **On** or **Off**.
3. Touch **Edit Time**, then enter the period of inactivity until the software goes into sleep mode.
4. Touch **Enter**.
5. Touch **OK**.

Power on the instrument

To power on the instrument from a powered-off state:

1. Touch anywhere on the touchscreen to determine if the instrument is in sleep mode. If the home screen displays, the instrument is already powered on.
2. If the home screen does not display, power on the instrument by pressing the switch on the rear panel.

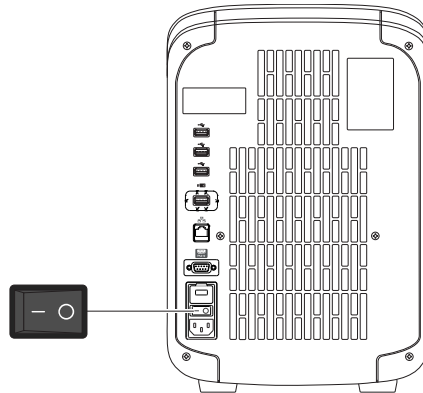

The instrument is ready to use when the home screen is displayed.

If left unattended (for about two hours), the instrument automatically enters sleep mode (enabled by default) to conserve power. Refer to the touchscreen Help system for step-by-step instructions for changing the sleep mode setting.

Power off the instrument



The instrument operates in low-power mode when not in use. However, the instrument can be powered off completely so that the components draw no power.

Note: If you will be shutting down the instrument for >1 week, see “Prepare the instrument to ship, move, or store” on page 67.

1. Power off the instrument from the power switch on the rear of the instrument.
2. Power off the computer.

Prepare the instrument to ship, move, or store

In the home screen:

1. Touch  **Settings** ▶ **Maintenance and Service** ▶ **Ship Prep Mode** ▶ **Next**.
2. Touch  to eject the instrument drawer.
3. Load the packing plate or an empty plate, then touch  to close the drawer.
4. Touch **Lock Block**.
5. Power off the instrument using the power switch on the back of the instrument.

The instrument is now ready to ship, move, or store.

Move the instrument



CAUTION! PHYSICAL INJURY HAZARD. Do not attempt to lift the instrument or any other heavy objects unless you have received related training. Incorrect lifting can cause painful and sometimes permanent back injury. Use proper lifting techniques when lifting or moving the instrument. At least two people are required to lift it.

IMPORTANT! Moving your instrument can create subtle changes in the alignment of the instrument optics. Recalibrate the instrument if necessary.

- Ensure that the surface on which you place the instrument can support at least 35 kg (77 lbs).
 - Ensure that the path to transport the instrument is clear of obstructions.
 - At least two people are needed to lift and carry the instrument.
 - Keep your spine in a good neutral position.
 - Bend at the knees and lift with your legs.
 - Do not lift an object and twist your torso at the same time.
 - Coordinate your intentions with your assistant before lifting and carrying.
-

IMPORTANT! After moving the instrument, perform an RNase P instrument verification run. If the run fails, perform ROI/ uniformity, background, and dye calibrations.

Return the instrument for service

The service process requires 2 to 3 weeks.

Before returning the instrument for service:

1. Back up the instrument (see “Backup or restore the instrument” on page 62).
2. In the home screen, touch  **Settings** ▶ **Instrument Settings** ▶ **Reset Factory defaults** to unlink from all Cloud accounts.
3. Set the instrument to Ship Prep Mode (see “Prepare the instrument to ship, move, or store” on page 67).

To return the instrument for service:

1. Contact your local customer care center or technical support group to obtain a copy of the Certificate of Instrument Decontamination, a service notification, a service call number, and packaging materials (if required).
 2. Follow the instructions in the form to decontaminate the instrument.
-

IMPORTANT! The instrument must be decontaminated before packing it for shipping.

3. Complete and sign a copy of the Certificate of Instrument Decontamination.
4. Fax the Certificate of Instrument Decontamination to the customer care center.

5. Pack the instrument in the provided packaging and follow the instructions in the table below.

Prepare	Include	Exclude
<ol style="list-style-type: none"> 1. Transfer any data files from the instrument. 2. Load an empty plate in the sample block. 3. Use the touchscreen to place the instrument in ship mode. <p>Note: The empty plate and ship mode protects the internal components of the instrument during transport.</p>	<ul style="list-style-type: none"> • Instrument • Completed and signed Certificate of Instrument Decontamination <p>Note: The instrument will not be accepted for service without a hard copy of the Certificate of Instrument Decontamination.</p>	<p>Any accessories, including:</p> <ul style="list-style-type: none"> • Power cord • Ethernet cable • USB drive • Wireless adapter <p>Note: If included with the instrument, these items will be disposed of during service and not returned.</p>

6. Attach the postage provided with the Certificate of Instrument Decontamination to the box, then ship the instrument to the designated facility.



Profile and instrument configuration tasks

■ Initial start up	70
■ Manage profiles	71
■ Enable SAE mode (Administrator only)	72
■ Require sign-in (Administrator only)	73
■ Enable remote instrument monitoring (Administrator only)	73
■ Update instrument software (Administrator only)	73
■ Restore factory defaults	74
■ Configure the network	74
■ Select a Cloud region (Administrator only)	75
■ Manage the instrument name (Administrator only)	75
■ Set the date and time	76
■ Manage the Sign Out Timer (Administrator only)	76

Initial start up

Perform these tasks during the initial start up or after you “Restore factory defaults” on page 74.

1. (Optional) “Configure the network” on page 74, or touch **Neither/Decide Later**.
2. (Optional) “Manage the instrument name (Administrator only)” on page 75.
3. “Set the date and time” on page 76.
4. “Select a Cloud region (Administrator only)” on page 75, or touch **Next** to continue.
5. “Create an administrator profile” on page 71.
6. “Link your instrument profile to Thermo Fisher Cloud” on page 24 or touch **Skip**.

Manage profiles

To	See
Create a profile	<ul style="list-style-type: none"> • “Create an administrator profile” on page 71 • “Create a new instrument profile” on page 23
Configure a profile	<ul style="list-style-type: none"> • “Link your instrument profile to your Thermo Fisher Cloud account” on page 24 • “Edit a user profile” on page 72
View or manage all profiles	<ul style="list-style-type: none"> • “View all user profiles (Administrator only)” on page 71 • “Manage all instrument profiles (Administrator only)” on page 71



Create an administrator profile

“Initial start up” on page 70 of the instrument automatically prompts for the creation of an administrator profile. The first profile created during instrument startup is given administrator privileges. Administrators can assign additional users administrative privileges (see “Manage all instrument profiles (Administrator only)” on page 71).

1. Touch **Name**, then enter a username and touch **Done**.
2. Touch **PIN**, then enter a four-digit numerical password and touch **Enter**.
Note: Touch the **Show PIN** checkbox to switch PIN display on or off.
3. Touch **Confirm PIN** and repeat the previous step.
4. Touch **Create profile**.

View all user profiles (Administrator only)

In the home screen:



1. Navigate to a list of all profiles.
 - Touch  **My Profile**, then touch the **All Profiles** tab.
 - Touch  **Settings** ▶ **Manage Users** ▶ **Manage Profiles**.

A list of Users, the date their profile was created, and User type is displayed.

2. Touch **Done**.

Manage all instrument profiles (Administrator only)

In the home screen:



1. Touch  **My Profile**, then touch the **All Profiles** tab.
Alternatively, touch  **Settings** ▶ **Manage Users** ▶ **Manage Profiles**, then touch the **All Profiles** tab.
2. Select the instrument profile to edit.

3. Edit the profile.
 - To delete the profile, touch **Delete profile** ▶ **Delete**.
 - To reset the PIN, touch **Reset PIN** ▶ **Reset**.
 - The PIN will be deleted, and the user will be directed to enter a new PIN upon the next sign in.
 - To enable or disable administrative privileges, slide the control to Administrator or Standard.
4. Touch **Done**.

Edit a user profile

“Sign In” on page 23 to access these functions. “Manage all instrument profiles (Administrator only)” on page 71 from this screen if you are an administrator.

In the home screen:

1. Touch  **My Profile**.
 Administrators can also navigate to this screen by touching  **Settings** ▶ **Manage Users** ▶ **Manage Profiles**.
2. Touch **Edit**.
3. Select the fields to edit, then make changes.
4. Touch **Done**.

Enable SAE mode (Administrator only)

Note: The Security, Audit, and e-Signature (SAE) module is available for QuantStudio™ 5 Systems only.

The SAE module works with the instrument and desktop software to record and restrict various user activities. Audits and e-Signatures are tracked within the desktop software.

In the home screen:

1. Touch  **Settings** ▶ **Instrument Settings** ▶ **SAE Mode**.
2. Slide the control **On** or **Off**.
3. Touch **OK**.

The following functions are disabled in SAE mode.

- Start a run from the instrument.
- Edit an instrument name.
- Edit an instrument date or time.
- Restore to factory defaults.
- Perform a software update.

Require sign-in (Administrator only)

In the home screen:

1. Touch  **Settings** ▶ **Manage Users** ▶ **Sign In Required**.
2. Slide the control **On** or **Off**.
3. Touch **Done**.

Requiring s user to sign in disables guest profiles.

Enable remote instrument monitoring (Administrator only)

In the home screen:



1. Touch  **Settings** ▶ **Maintenance and Service** ▶ **Monitoring**.
2. Configure your instrument monitoring settings.

Option	Description
Remote Monitoring Service	Slide the control On or Off to enable or disable the instrument to automatically notify Thermo Fisher Scientific support teams in real time of potential instrument issues. Data and experiments are not monitored.
Thermo Fisher Cloud Monitor	Slide the control On or Off to enable or disable real-time monitoring of amplification plots from your Thermo Fisher Cloud dashboard.

3. Touch **OK**.

Update instrument software (Administrator only)

In the home screen:

1. Touch  **Settings** ▶ **Maintenance and Service** ▶ **Software Update**.
2. Touch  **USB** or  **Cloud** to select the location of the update files.
3. When prompted, confirm your request to update the software.

Restore factory defaults

IMPORTANT! Back up the instrument before restoring factory defaults (see “Backup or restore the instrument” on page 62).

In the home screen:

1. Touch  **Settings** ▶ **Instrument Settings** ▶ **Restore Factory Defaults**.
2. Touch **Restore Factory Defaults**.
3. Power **Off**, then power **On** the instrument to effect the change in settings.
All profile and personal information will be permanently removed from the instrument.

Following a factory default restore, follow the procedures described in “Initial start up” on page 70.

Configure the network



What do you want to do?

 “Set up a wired connection” on page 74

 “Set up a wireless connection” on page 75

Set up a wired connection

In the home screen:

1. Touch  **Settings** ▶ **Instrument Settings** ▶ **Network Connection** ▶  **Wired**.
2. Touch a radio button to choose to connect to a network by DHCP or a Static IP address on the Network Configuration screen.

Option	Action
Automatic	Touch DHCP
Manual	<ol style="list-style-type: none"> 1. Touch Static IP 2. Enter the appropriate IP addresses for the instrument, the Subnet Mask, and, optionally, the Default Gateway, the Primary DNS Server, and the Secondary DNS Server using the numeric editor. Addresses are in the form of X.X.X.X, where each X is a 3-digit number, from 001 to 255.



Note: Ask your system administrator if the IP address is assigned statically or dynamically. For static addresses, you need to know the IP address for the instrument, the subnet mask, and the default gateway.

3. Touch **OK** to save the changes and return to the Network Connection screen.

“Create an administrator profile” on page 71 to continue the initial start up of the instrument.

Set up a wireless connection

In the home screen:

1. Touch  **Settings** ▶ **Instrument Settings** ▶ **Network Connection** ▶  **Wireless** to display a list of the available networks.
2. Select a network or touch **Join other network**, then enter the network password and touch **Enter**.
If you choose Join other network, enter the network name and security type.
3. Touch **Join** to continue or **Cancel** to exit.
4. In the Network Connection Complete screen, touch **Next** to continue.
5. Touch **OK**.
6. Edit the Network details in the Network Configuration screen or touch **Done**.

Proceed to “Create an administrator profile” on page 71 to continue the initial start up of the instrument.

Select a Cloud region (Administrator only)

During the initial startup, you will be automatically prompted to select a Cloud region. Return to the selection through  **Settings**, if necessary.

In the home screen:

1. Touch  **Settings** ▶ **Instrument Settings** ▶ **Cloud Region**.
2. Touch a region.
The server used to store your data is located in this region.
3. Touch **OK**.

Manage the instrument name (Administrator only)

In the home screen:

1. Touch  **Settings** ▶ **Instrument Settings** ▶ **Instrument Name**.
2. Touch the Instrument Name field, enter an instrument name, then touch **Done**.
3. (Optional) Touch **Add Avatar** to associate an avatar with your instrument. You must insert a USB drive with images to use this option.
4. Touch **OK**.

Set the date and time

In the home screen:

1. Touch  **Settings** ▶ **Instrument Settings** ▶ **Date/Time**.
2. Select a time zone from the drop-down list.
3. Select a date format.
 - a. Touch **Date Format**.
 - b. Select the radio button of your preferred date format.
 - c. Touch **Next**, touch the date field, and enter the date.
 - d. Touch **Enter**, then touch **Done**.
4. Select a time format.
 - a. Touch **Time Format**.
 - b. Slide the control left or right to choose a 12-hour or 24-hour clock.
 - c. Touch **Next**, touch the time field, and enter the time.
 - d. Touch **Enter**, then touch **Done**.
5. Touch **Done**.

Manage the Sign Out Timer (Administrator only)

In the home screen:

1. Touch  **Settings** ▶ **Manage Users** ▶ **Sign Out Timer**.
2. Touch the **Edit Time** field, then enter the desired duration of inactivity before automatic user sign out.
3. Touch **Enter**, then touch **Done**.



Install and connect the instrument to a network

- Workflow: Install and connect to a network 77
- Before you begin 78
- Unpack and install the instrument 78
- Power on and follow the startup wizard 79
- Connect the instrument and the computer directly or to a LAN 79
- Instrument and computer connections 81
- Download and install the QuantStudio™ Design and Analysis desktop Software 82
- Networking 84

Workflow: Install and connect to a network

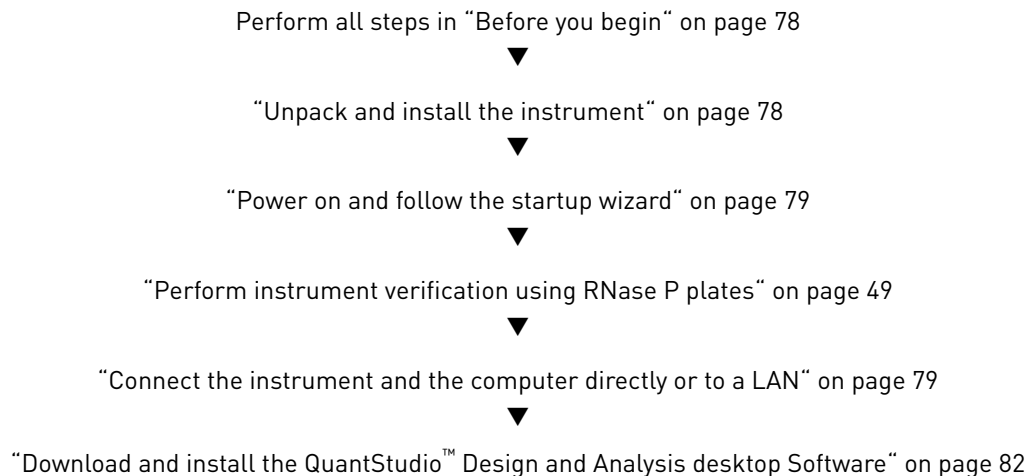



Before you begin

This section provides instructions for customer installation of the computer and the instrument. For installation by a field service engineer (FSE), contact Support to order a service call.

Before starting the installation::

- Review “Networking” on page 84 to determine the configuration for your instrument and obtain the network information you need
- Review site requirements in *QuantStudio™ 3 and 5 Real-Time PCR Systems Site Preparation Guide* (Pub. no. MAN0010405)
- Review the connections in “Instrument and computer connections” on page 81

Unpack and install the instrument

1. Prepare the installation site as described in *QuantStudio™ 3 and 5 Real-Time PCR Systems Site Preparation Guide* (Pub. no. MAN0010405).
2. Follow the pre-printed instructions on the instrument box to unpack the instrument, accessories, and reference documentation. Save the packing material for future use or recycle it.

The instrument box contains:

- One instrument
 - Accessories: power cable, Ethernet cable, USB drive, reaction tube retainer
 - Shipping plate
- Note:** Save the shipping plate but do not use it to operate the instrument.
- Reference documentation: Welcome note, unpacking and set up instructions card, system documentation insert

If you ordered the wireless adapter, it is provided separately.

3. Place the instrument on the bench.
4. Plug the power cable into the instrument power port at the rear of the instrument and the other end into a receptacle.
5. Connect your instrument as required by your network configuration (see “Supported network configuration options” on page 84 and “Instrument and computer connections” on page 81).
 - Connect an Ethernet cable to the connector on the rear of the instrument and to a computer or a LAN.
 - or*
 - Connect wirelessly via the wireless adapter.

Note: Do not connect the High Power USB WiFi Module (Cat. no. A26774) to the instrument if it is connected to a network by an Ethernet cable. Configuring the instrument for both wired and wireless connection can interfere with instrument operation.



Power on and follow the startup wizard

1. Power on the instrument.
2. Follow the startup wizard through the following tasks:
 - Accept license agreement
 - Choose networking option
Select **Wired** or **Wireless** as needed for your configuration (see “Supported network configuration options” on page 84)
 - Configure instrument
Specify time zone, date format, and time format.
 - Create administrator profile

You can perform any of the steps above at a later time if you do not have the information needed to complete the startup screens. See “Configure instrument settings” on page 25.

IMPORTANT! Before using the instrument for the first time, we recommend that you “Perform instrument verification using RNase P plates” on page 49.

Connect the instrument and the computer directly or to a LAN

This section describes direct wired connection of the computer provided by Thermo Fisher Scientific to the instrument or to a LAN.

Do not connect a customer-provided computer to the instrument.

1. Connect an Ethernet cable from the instrument or a LAN to the computer.
2. Power on the computer, then log in using a Windows™ Administrator account.
3. In the Windows™ desktop, right-click **My Network Places** ▶ **Properties**.
4. Right-click **Local Area Connection**, then select **Properties**.
5. Select **Internet Protocol (TCP/IP)** ▶ **Properties**.



6. Set the Internet Protocol (TCP/IP) Properties for either DHCP or Static IP communication:

Network configuration	Action
DHCP	<ol style="list-style-type: none">1. Select Obtain an IP address automatically.2. Set the DNS address. If the computer obtains DNS addresses:<ul style="list-style-type: none">• Automatically – Select Obtain DNS server address automatically.• Statically – Select Use the following DNS address, then enter the address of the preferred and alternate DNS servers (if available).
Static IP	<ol style="list-style-type: none">1. Select Use the following IP address.2. In the IP Address field, enter the static IP address.3. If necessary, enter a subnet mask.4. If necessary, enter a static gateway address in the Default Gateway field.

7. If your network requires advanced TCP/IP setup (such as WINS), define the settings:
- a. Click **Advanced** in the Internet Protocol (TCP/IP) Properties dialog box.
 - b. Define the IP Settings, DNS, and WINS tabs as instructed by your systems administrator, then click **OK**.
8. Close all dialog boxes by clicking **OK**, then re-start the computer.
The computer is now visible to other computers on the network.

Instrument and computer connections

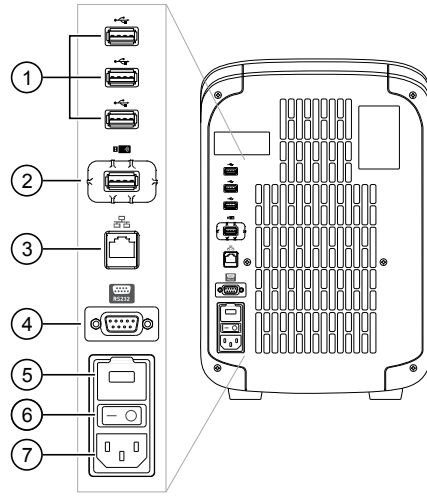

Figure 3 Instrument back panel

- | | |
|---|-------------------------------------|
| ① USB ports | ④ RS232 Port – For service use only |
| ② WiFi USB port – Connect USB wireless adapter for wireless network access (ordered separately) | ⑤ Fuse Cover |
| ③ Ethernet Port – RJ45 port for 10/100 Mbps Ethernet communication with the instrument | ⑥ Power Switch |
| | ⑦ Power Port – 100 to 240 VAC |

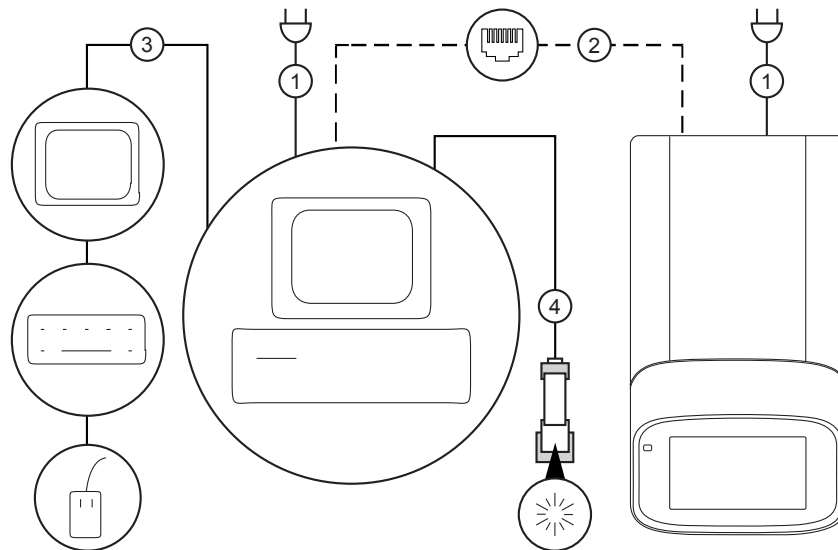

Figure 4 Instrument-to-computer connections

- | | |
|---|---|
| ① Detachable power supply cord compatible with local power supply receptacle. | ③ Connection between the computer and the monitor, keyboard, and mouse. |
| ② Connection between the computer and the instrument (direct connection). | ④ Connection between the computer and the handheld barcode scanner. |

Download and install the QuantStudio™ Design and Analysis desktop Software

Computer requirements for the desktop software

If you purchased a computer provided by Thermo Fisher Scientific, you can install the QuantStudio™ Design and Analysis desktop Software and use it to control the instrument.

We do not support the use of customer-provided computers to control the instrument.

However, you can install the desktop software on a customer-provided computer and use the software to create templates and analyze data. Minimum requirements for a customer-provided computer are:

- Windows™ 7 operating system (32-bit or 64-bit)
- Pentium® 4 processor or compatible
- 4 GB RAM
- 500 GB hard drive
- Monitor resolution 1280x1024

Download the desktop software

1. Sign in to your account at **thermofisher.com**.

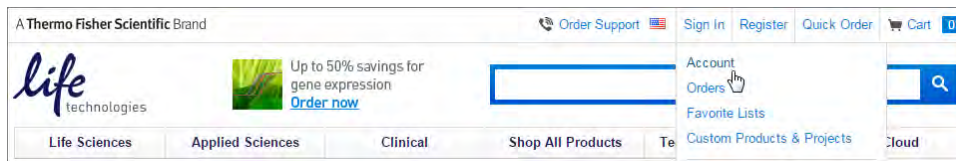

Note: If you do not have an account, create one.

2. Go to <http://www.thermofisher.com/quantstudio3-5softwaredownloads>.
3. Download the software and the example files.

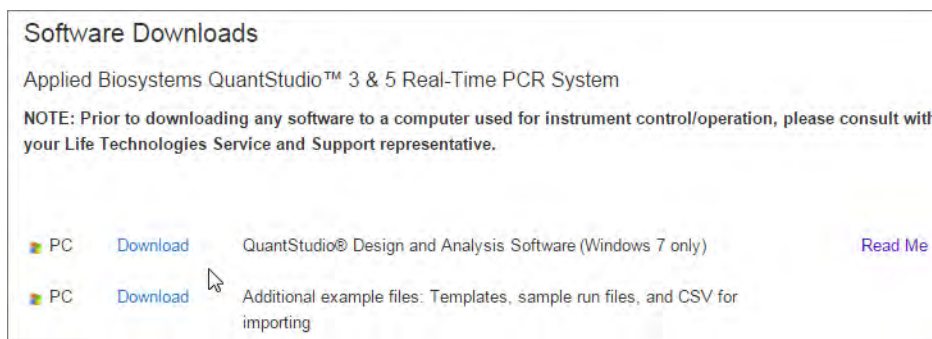

Install the software

1. Log in to the computer on which you are installing the software with a Windows™ Administrator account.
2. Unzip the downloaded software and example files.

3. Double-click **setup.exe**.

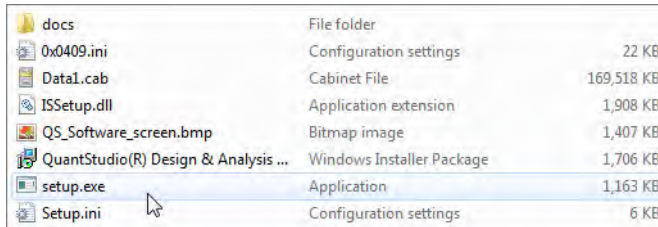

4. Follow the InstallShield Wizard prompts to install the software.
5. Accept the License Agreement.
6. Select **Typical** as the setup preference, then click **Next**.
7. If you are installing the software on a computer provided by Thermo Fisher Scientific, install the software on the D:\ drive. If you are installing on a customer-provided computer, install the software in your preferred location.



8. Click **Finish**.



Networking

IMPORTANT! This section provides general networking information. It *does not* provide adequate detail to integrate the instrument into all possible network architectures. Because a network may contain advanced features (such as a firewall or network domains), we recommend that you consult a network administrator before connecting the instrument to your laboratory network.

Supported network configuration options

We support the following direct, LAN (local area network) and Cloud network configurations. Configurations other than those listed are not recommended.

DO NOT connect the High Power USB WiFi Module (Cat. no. A26774) to the instrument if it is connected to a network by an Ethernet cable. Configuring the instrument for both wired and wireless connection can interfere with instrument operation.

Connection	Requirements
<p>Direct</p> 	<ul style="list-style-type: none"> A computer provided by Thermo Fisher Scientific installed with the QuantStudio™ Design and Analysis desktop Software Direct Ethernet connection instrument-to-computer
<p>Local area network (LAN) connection</p> 	<ul style="list-style-type: none"> A computer provided by Thermo Fisher Scientific installed with the QuantStudio™ Design and Analysis desktop Software Direct Ethernet connection <i>or</i> wireless connection instrument-to-LAN (Wi-Fi module connected to instrument is required for wireless connection) Direct Ethernet connection <i>or</i> wireless connection computer-to-LAN Open network ports: 5353 and 7000 <p>Multiple computers can access the same instrument through the network, but only one computer can start a run at any given time.</p>
<p>Cloud</p> 	<ul style="list-style-type: none"> A Microsoft™ Windows™ or Apple™ Macintosh™ computer with internet connection and web browsing access (for Cloud access only, no instrument control) Direct Ethernet connection <i>or</i> wireless connection instrument-to-Cloud (Wi-Fi module connected to instrument is required for wireless connection) Direct Ethernet connection <i>or</i> wireless connection computer-to-Cloud Open network ports: 5353 and 7000



Control and monitor networked instruments

When the instrument is connected to a network:

- Computers on the network that are running the desktop software can control the instrument. Networked instruments can be controlled by only one computer at a time.
- Instruments linked to the Cloud cannot be controlled remotely. However, you can:
 - Remotely access the cloud software to create (and analyze) experiments.
 - From the instrument, download the experiments and start a run.
 - Monitor a run from the Cloud in real time.

About the Ethernet port

The Ethernet port of the instrument supports:

- Static IP network service with subnet mask, primary and secondary data network service (DNS), and default gateway settings, or dynamic host configuration protocol (DHCP) network service.

- mDNS/DNS for local domains.

Note: Because mDNS is limited to direct network connections, an instrument configured for mDNS may not be visible to other nodes that are separated by a router, hub, or another network device.

- IPv4 linklocal (IPV4LL) in the RFC (also known as Automatic Private IP Addressing [APIPA] or Internet Protocol Automatic Configuration [IPAC])

Note: When an instrument is set for DHCP, APIPA is automatically enabled, and the instrument provides an IP address when no address is supplied by the DHCP server.

Firewall ports that must be open

Ports	Condition
80/443	Standard ports for instrument-to-Cloud and computer-to-Cloud connection
mDNS, 7000	Instrument-to-computer connection
mDNS, 5353	Instruments discovery

Networking guidelines and best practices

- Consult a network administrator before connecting the instrument to a network.
- To enable the full functionality of the software, the computer requires a network connection.
- Open the firewall port for the instruments to be discovered.
See “Firewall ports that must be open” on page 85 for information on relevant ports to open on the computer and router.
- Observe the restrictions to mDNS and Autodiscovery.

The instrument supports mDNS but only when the instrument and computer share a direct network connection and are within the same subnet. Network computers that are separated from the instrument by a router, hub, or another network device may not be able to access the instrument by its host name.



Appendix A Install and connect the instrument to a network

Networking

- Confirm the uniqueness of the instrument name.
 - The instrument name must be unique within the subnet. The desktop software can automatically discover instruments on the link-local network.
 - The instrument does not test the uniqueness of the instrument name within the subnet when it is set.



Troubleshooting

Observation	Possible cause	Recommended action
Inconsistent communication between instrument-computer or instrument-Cloud	Instrument is configured for both wired and wireless network connection.	Ensure only one connectivity option is plugged into the instrument (either an Ethernet cable <i>or</i> wireless adapter, but not both).
		Configure for wired <i>or</i> wireless network connection.
	Weak or unstable internet connection, especially if configured for wireless.	Change configuration to wired connection.
		Use a wireless network with a stronger or more consistent signal.
The connection between instrument and computer not recognized	The connection is not fully established.	Power the instrument off, then power on again.
Insufficient disk space message	Insufficient disk space to save a run.	<ol style="list-style-type: none"> In the home screen, touch  Settings ▶ Run History ▶ Manage. Delete or transfer experiments from the instrument.
Touchscreen is black	Instrument is in sleep mode.	Touch anywhere on the instrument touchscreen.
	Instrument is not powered on.	If you touch the instrument touchscreen and it remains black, check if the instrument is powered on. The power switch is located on the rear panel of the instrument.
		If the instrument does not power on, check that the power supply is properly connected.
		If the instrument does not power on and the power supply is properly connected, contact Support.
Forgot PIN for instrument profile	Non-administrator forgot instrument profile PIN.	See “Manage all instrument profiles (Administrator only)” on page 71.
	Administrator forgot instrument profile PIN.	Have another administrator reset the PIN for the forgotten-PIN profile (see “Manage all instrument profiles (Administrator only)” on page 71).
		If there is not another administrator profile on the instrument, you must restore factory defaults (see “Restore factory defaults” on page 74).



Parts and materials

- Kits, consumables, and accessories 88
- 96-Well (0.2-mL) consumables 88
- 384-well consumables 89
- 96-Well Fast (0.1-mL) consumables 90
- QuantStudio™ 3 and 5 Systems accessories 91
- General-use materials and consumables 91

Kits, consumables, and accessories

The following kits, consumables, and reagents are used with the QuantStudio™ 3 and 5 Systems.

Unless otherwise indicated, all materials are available through thermofisher.com.

Note: Store ROI/Uniformity, Background, Dye, and RNase P plates at -20°C and use them by the expiration date on the packaging. All other consumables can be stored at room temperature.

96-Well (0.2-mL) consumables

Consumable	Contents	Cat. no.
MicroAmp™ Optical 8-Cap Strip	300 strips	4323032
MicroAmp™ Optical 8-Tube Strip (0.2 mL)	125 strips	4316567
MicroAmp™ Optical Tube without Cap (0.2 mL)	2000 tubes	N8010933
MicroAmp™ 96-Well Tray/Retainer Set (blue) (for 0.2 mL)	10 sets	4381850
MicroAmp™ Optical 96-Well Reaction Plate (0.2 mL)	10 plates	N8010560
	500 plates	4316813
MicroAmp™ EnduraPlate™ Optical 96-Well Reaction Plate with Barcode (blue) (0.2 mL)	20 plates	4483343
MicroAmp™ Optical Adhesive Film Kit	1 kit	4313663



Calibration or instrument verification plate	Cat. no.
96-Well Region of Interest (ROI) and Background Plates (2 plates)	4432364
QuantStudio™ 3 or 5 10-Dye Spectral Calibration Kit, 96-Well 0.2-mL	A26343
96-Well 0.2-mL Spectral Calibration Plate 1 (containing FAM™, VIC™, ROX™, and SYBR™ dyes)	A26331
96-Well 0.2-mL Spectral Calibration Plate 2 (containing ABY™, JUN™, and MUSTANG PURPLE™ dyes)	A26332
96-Well 0.2-mL Spectral Calibration Plate 3 (containing TAMRA™, NED™, and Cy ^{fi} 5 dyes)	A26333
96-Well 0.2-mL TaqMan™ RNase P Instrument Verification Plate	4432382

384-well consumables

Consumable	Contents	Cat. no.
MicroAmp™ Optical 384-Well Reaction Plate with Barcode	50 plates	4309849
	500 plates	4326270
	1000 plates	4343814
MicroAmp™ EnduraPlate™ Optical 384-Well Reaction Plate with Barcode (clear)	20 plates	4483285
	500 plates	4483273
MicroAmp™ Optical Adhesive Film Kit	1 kit	4313663

Calibration or instrument verification plate	Cat. no.
384-Well Region of Interest (ROI) and Background Plates (2 plates)	4432320
QuantStudio™ 3 or 5 10-Dye Spectral Calibration Kit, 384-Well	A26341
384-Well Spectral Calibration Plate 1 (containing FAM™, VIC™, ROX™, TAMRA™, and SYBR™ dyes)	A26334
384-Well Spectral Calibration Plate 2 (containing ABY™, JUN™, MUSTANG PURPLE™, NED™, and Cy ^{fi} 5 dyes)	A26335
384-Well TaqMan™ RNase P Instrument Verification Plate	4455280



96-Well Fast (0.1-mL) consumables

Consumable	Contents	Cat. no.
MicroAmp™ Optical 8-Cap Strip	300 strips	4323032
MicroAmp™ Optical Fast 8-Tube Strip (0.1 mL)	125 strips	4358293
MicroAmp™ Optical Fast Tube with Cap (0.1 mL)	1000 tubes	4358297
MicroAmp™ 96-Well Tray (blue) (for 0.1 mL)	10 trays	4379983
MicroAmp™ Optical 96-Well Fast Reaction Plate (0.1 mL)	10 plates	4346907
MicroAmp™ EnduraPlate™ Optical 96-Well Fast Reaction Plate with Barcode (clear) (0.1 mL)	20 plates	4481194
	500 plates	4483494
MicroAmp™ Optical Adhesive Film Kit	1 kit	4313663

Calibration or instrument verification plate	Cat. no.
96-Well Fast Region of Interest (ROI) and Background Plates (2 plates)	4432426
QuantStudio™ 3 or 5 10-Dye Spectral Calibration Kit, 96-Well 0.1-mL	A26342
96-Well 0.1-mL Spectral Calibration Plate 1 (containing FAM™, VIC™, ROX™, and SYBR™ dyes)	A26336
96-Well 0.1-mL Spectral Calibration Plate 2 (containing ABY™, JUN™, and MUSTANG PURPLE™ dyes)	A26337
96-Well 0.1-mL Spectral Calibration Plate 3 (containing TAMRA™, NED™, and Cy ^{fi} 5 dyes)	A26340
96Well Fast TaqMan™ RNase P Instrument Verification Plate	4351979



QuantStudio™ 3 and 5 Systems accessories

Accessory	Contents	Cat. no.
MicroAmp™ Multi-Removal Tool	1 tool	4313950
MicroAmp™ Cap Installing Tool (handle style)	1 tool	4330015
MicroAmp™ Optical Adhesive Film Kit	1 kit	4313663
MicroAmp™ Optical Adhesive Film	25 films	4360954
	100 films	4311971
MicroAmp™ Adhesive Film Applicator	5 applicators	4333183
Real Time PCR Grade Water	10 × 1.5 mL tubes	AM9935
Handheld Barcode Scanner	1 scanner	448842
High Power USB WiFi Module	1 module	A26774

General-use materials and consumables

The following general-use materials and consumables are required to calibrate, maintain, and operate the instrument. Unless indicated otherwise, all materials shown below are available from major laboratory suppliers (MLS).

Material/consumable	Source
Bleach, 10% solution	MLS
Centrifuge with 96-well plate buckets	MLS
Cotton or nylon swabs and lint-free cloths	MLS
Ethanol, 95% solution	MLS
Optical clear adhesive film for PCR	MLS
Pipettors, 100-µL and 200-µL (with pipette tips)	MLS
Powder-free gloves	MLS
Safety glasses	MLS
Screwdriver, flathead	MLS
Tissue, lint-free	MLS
Deionized water	MLS



Instrument specification and layout

- Configured system dimensions 93
- Electrical requirements 94
- Environmental requirements 95
- Network requirements 95

Note: For information on instrument components and connections, see “Instrument and computer connections” on page 81.

Configured system dimensions

Allow space for the configured instrument. A typical setup is shown below (dimensions are rounded to nearest unit).

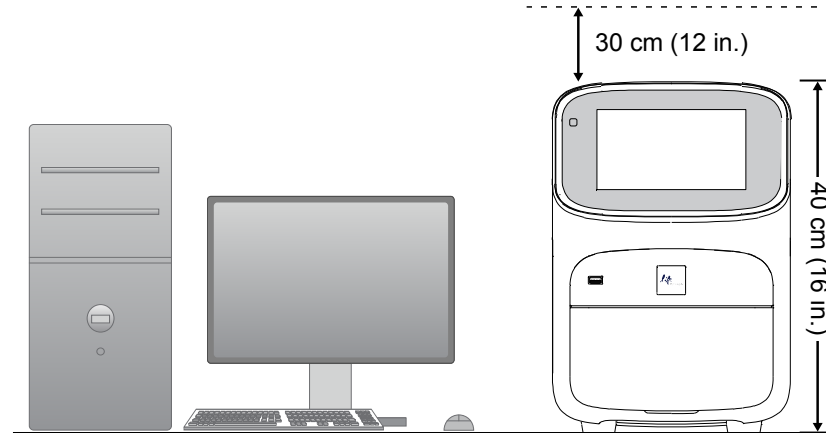
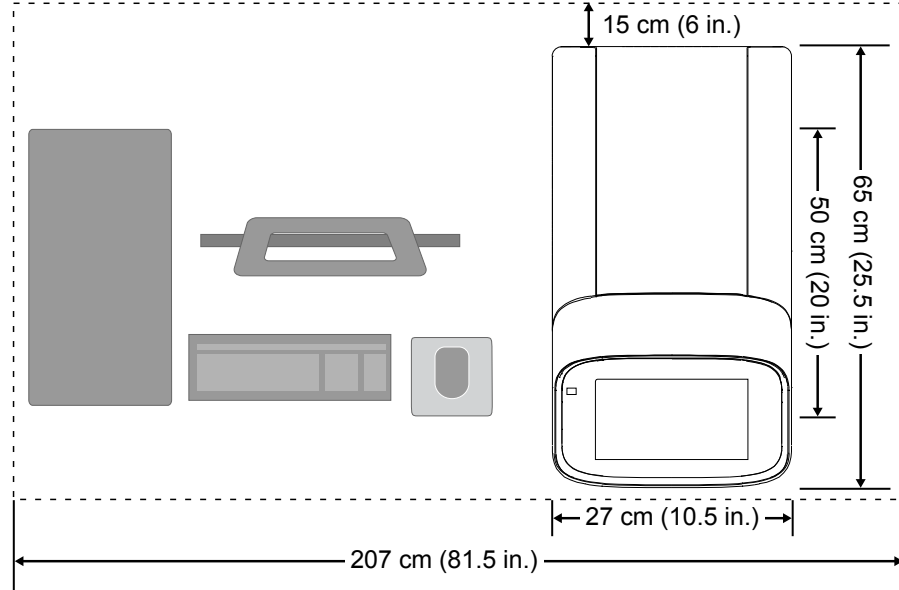

Instrument clearances

During instrument setup and maintenance, it is necessary to access the back of the instrument. If the back of the instrument faces a wall, it will be necessary to have enough space to rotate the instrument on the bench for access.

IMPORTANT! For safety, the power outlet used for powering the instrument must be accessible at all times.

Component	Top	Front	Sides	Back
QuantStudio™ 3 and 5 Real-Time PCR Systems	30.5 cm (12 in.)	30.5 cm (12 in.)	15.25 cm (6 in.)	15.25 cm (6 in.)
Computer <i>(Optional)</i>	—	15.25 cm (6 in.)	—	15.25 cm (6 in.)

Electrical requirements

 **WARNING!** For safety, the power outlet used for powering the instrument must be accessible at all times. See “Instrument clearances” for information about the space needed between the wall and the instrument. In case of emergency, you must be able to immediately disconnect the main power supply to all the equipment. Allow adequate space between the wall and the equipment so that the power cords can be disconnected in case of emergency.

- Electric receptacle with grounding capability
- Maximum power dissipation: 960 W (approximate, not including computer and monitor)
- Mains AC line voltage tolerances must be up to ± 10 percent of nominal voltage

Device	Rated voltage	Circuit required	Rated frequency	Rated power
QuantStudio™ 3 and 5 Systems	100–240 $\pm 10\%$ VAC ^[1]	10 A	50/60 Hz	960 W
Computer (desktop)	100–240 $\pm 10\%$ VAC	10 A	50/60 Hz	125 VA
Monitor				65 VA
Computer (laptop)	100–240 $\pm 10\%$ VAC	10 A	50/60 Hz	90 VA

^[1] If the supplied power fluctuates beyond the rated voltage, a power line regulator may be required. High or low voltages can adversely affect the electronic components of the instrument.

Environmental requirements

Table 2 Environmental requirements

Condition	Acceptable range
Installation site	Indoor use only
Electromagnetic interference	Do not use this device in close proximity to sources of strong electromagnetic radiation (for example, unshielded intentional RF sources). Strong electromagnetic radiation may interfere with the proper operation of the device.
Altitude	Between sea level and 2000 m (6500 ft.) above sea level
Operating conditions	<ul style="list-style-type: none"> Temperature: 15 to 30°C (60 to 85°F) <p>Note: The room temperature must not fluctuate more than $\pm 2^\circ\text{C}$ over a 2-hour period.</p> <ul style="list-style-type: none"> Humidity: 15–80% relative humidity (noncondensing)
Thermal output	During operation, the net thermal output, based on the actual current draw of the instrument, is expected to be approximately 960 W (3275 Btu/h).
Vibration	Ensure that the instrument is not adjacent to strong vibration sources, such as a centrifuge, pump, or compressor. Excessive vibration will affect instrument performance.
Pollution degree	<p>The instrument has a Pollution Degree rating of II. The instrument may only be installed in an environment that has nonconductive pollutants such as dust particles or wood chips. Typical environments with a Pollution Degree II rating are laboratories and sales and commercial areas.</p> <p>The noise output of the instrument is ≤ 60 dB when running.</p>
Other conditions	<p>Ensure the instrument is located away from any vents that could expel particulate material onto the instrument components.</p> <p>Avoid placing the instrument and computer adjacent to heaters, cooling ducts, or in direct sunlight.</p>

Network requirements

The instrument:

- Is factory-configured for IPv4 TCP/IP communication and includes a fast Ethernet adapter (10/100 Mbps) with an RJ45-type connector for integrating the device into a local area network (LAN).
- Can alternatively be configured for wireless networking (wireless dongle required, sold separately as an optional accessory).

The instrument should be configured for *either* wired or wireless networking, not both.



If a field service representative is to install your instrument:

- If the instrument will be connected to a LAN, an active, tested network jack must be in place before the scheduled installation date.
- A representative from your information technologies department must be available during the installation to help connect the instrument to your network.

Required materials:

- Wired: CAT6 Ethernet cable of sufficient length with RJ45 connectors (for a 1000 Mbps network connection or a CAT5 for a 100 Mbps connection)
or
- Wireless: 802.11b/g/n Single-Band Wireless Dongle (Cat. no. A26774, ordered separately)



Safety

■ Symbols on this instrument	98
■ Safety alerts on this instrument	100
■ Safety information for instruments not manufactured by Thermo Fisher Scientific	101
■ Instrument safety	101
■ Safety and electromagnetic compatibility (EMC) standards	103
■ Chemical safety	105
■ Biological hazard safety	106







 **WARNING! GENERAL SAFETY.** Using this product in a manner not specified in the user documentation may result in personal injury or damage to the instrument or device. Ensure that anyone using this product has received instructions in general safety practices for laboratories and the safety information provided in this document.







- Before using an instrument or device, read and understand the safety information provided in the user documentation provided by the manufacturer of the instrument or device.
 - Before handling chemicals, read and understand all applicable Safety Data Sheets (SDSs) and use appropriate personal protective equipment (gloves, gowns, eye protection, etc). To obtain SDSs, see the “Documentation and Support” section in this document.
-

Symbols on this instrument



Symbols may be found on the instrument to warn against potential hazards or convey important safety information. In this document, the hazard symbol is used along with one of the following user attention words:

- **CAUTION!** – Indicates a potentially hazardous situation that, if not avoided, may result in minor or moderate injury. It may also be used to alert against unsafe practices.
- **WARNING!** – Indicates a potentially hazardous situation that, if not avoided, could result in death or serious injury.
- **DANGER!** – Indicates an imminently hazardous situation that, if not avoided, will result in death or serious injury.

Symbol	English	Français
	Caution, risk of danger Consult the manual for further safety information.	Attention, risque de danger Consulter le manuel pour d'autres renseignements de sécurité.
	Caution, risk of electrical shock	Attention, risque de choc électrique
	Moving parts	Parties mobiles
	Caution, hot surface	Attention, surface chaude
	Potential biohazard	Danger biologique potentiel
	Ultraviolet light	Rayonnement ultraviolet
	Potential slipping hazard	Danger de glisser potentiel
I	On	On (marche)
○	Off	Off (arrêt)
⓪	On/Off	On/Off (marche/arrêt)
⏻	Standby	En attente



Symbol	English	Français
	Earth (ground) terminal	Borne de (mise à la) terre
	Protective conductor terminal (main ground)	Borne de conducteur de protection (mise à la terre principale)
	Terminal that can receive or supply alternating current or voltage	Borne pouvant recevoir ou envoyer une tension ou un courant de type alternatif
	Terminal that can receive or supply alternating or direct current or voltage	Borne pouvant recevoir ou envoyer une tension ou un courant continu ou alternatif
	Do not dispose of this product in unsorted municipal waste	Ne pas éliminer ce produit avec les déchets usuels non soumis au tri sélectif.
	CAUTION! To minimize negative environmental impact from disposal of electronic waste, do not dispose of electronic waste in unsorted municipal waste. Follow local municipal waste ordinances for proper disposal provision and contact customer service for information about responsible disposal options.	 CAUTION! Pour minimiser les conséquences négatives sur l'environnement à la suite de l'élimination de déchets électroniques, ne pas éliminer ce déchet électronique avec les déchets usuels non soumis au tri sélectif. Se conformer aux ordonnances locales sur les déchets municipaux pour les dispositions d'élimination et communiquer avec le service à la clientèle pour des renseignements sur les options d'élimination responsable.

Conformity symbols

Conformity mark	Description
	Indicates conformity with safety requirements for Canada and U.S.A.
	Indicates conformity with European Union requirements for safety and electromagnetic compatibility.
	Indicates conformity with Australian standards for electromagnetic compatibility.

Safety alerts on this instrument

Additional text may be used with one of the symbols described above when more specific information is needed to avoid exposure to a hazard. See the following table for safety alerts found on the instrument.

English	French translation
 CAUTION! Hazardous chemicals. Read the Safety Data Sheets (SDSs) before handling.	ATTENTION! Produits chimiques dangereux. Lire les fiches signalétiques (FS) avant de manipuler les produits.
 CAUTION! Hazardous waste. Refer to SDS(s) and local regulations for handling and disposal.	ATTENTION! Déchets dangereux. Lire les fiches signalétiques (FS) et la réglementation locale associées à la manipulation et à l'élimination des déchets.

Location of safety labels on the instrument

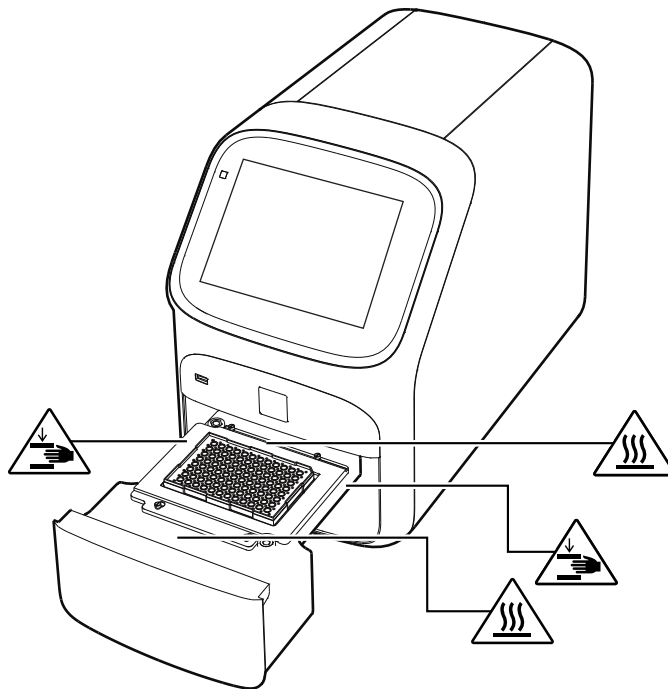

Safety information for instruments not manufactured by Thermo Fisher Scientific

Some of the accessories provided as part of the instrument system are not designed or built by Thermo Fisher Scientific. Consult the manufacturer's documentation for the information needed for the safe use of these products.

Instrument safety

General



CAUTION! Do not remove instrument protective covers. If you remove the protective instrument panels or disable interlock devices, you may be exposed to serious hazards including, but not limited to, severe electrical shock, laser exposure, crushing, or chemical exposure.



CAUTION! Solvents and Pressurized fluids. Wear eye protection when working with any pressurized fluids. Use caution when working with any polymeric tubing that is under pressure:

- Extinguish any nearby flames if you use flammable solvents.
 - Do not use polymeric tubing that has been severely stressed or kinked.
 - Do not use polymeric tubing with tetrahydrofuran or nitric and sulfuric acids.
 - Be aware that methylene chloride and dimethyl sulfoxide cause polymeric tubing to swell and greatly reduce the rupture pressure of the tubing.
 - Be aware that high solvent flow rates (~40mL/min) may cause a static charge to build up on the surface of the tubing and electrical sparks may result.
-

Physical injury



CAUTION! Moving and Lifting Injury. The instrument is to be moved and positioned only by the personnel or vendor specified in the applicable site preparation guide. Improper lifting can cause painful and permanent back injury.

Things to consider before lifting or moving the instrument or accessories:

- Depending on the weight, moving or lifting may require two or more persons.
- If you decide to lift or move the instrument after it has been installed, do not attempt to do so without the assistance of others, the use of appropriate moving equipment, and proper lifting techniques.
- Ensure you have a secure, comfortable grip on the instrument or accessory.
- Make sure that the path from where the object is to where it is being moved is clear of obstructions.
- Do not lift an object and twist your torso at the same time. Keep your spine in a good neutral position while lifting with your legs.
- Participants should coordinate lift and move intentions with each other before lifting and carrying.
- For smaller packages, rather than lifting the object from the packing box, carefully tilt the box on its side and hold it stationary while someone else slides the contents out of the box.





CAUTION! Moving Parts. Moving parts can crush, pinch and cut. Keep hands clear of moving parts while operating the instrument. Disconnect power before servicing.



WARNING! Do not attempt to lift or move the instrument without the assistance of others. Use appropriate moving equipment and proper lifting technique, improper lifting may result in serious injury.

Electrical

 **WARNING! Fuse Installation.** Before installing the instrument, verify that the fuses are properly installed and the fuse voltage matches the supply voltage. Replace fuses only with the type and rating specified for the unit. Improper fuses can damage the instrument wiring system and cause a fire.

 **WARNING! Ensure appropriate electrical supply.** For safe operation of the instrument:

- Plug the system into a properly grounded receptacle with adequate current capacity.
- Ensure the electrical supply is of suitable voltage.
- Never operate the instrument with the ground disconnected. Grounding continuity is required for safe operation of the instrument.

 **WARNING! Power Supply Line Cords.** Use properly configured and approved line cords for the power supply in your facility.

 **WARNING! Disconnecting Power.** To fully disconnect power either detach or unplug the power cord, positioning the instrument such that the power cord is accessible.

Cleaning and decontamination

 **CAUTION! Cleaning and Decontamination.** Use only the cleaning and decontamination methods specified in the manufacturer's user documentation. It is the responsibility of the operator (or other responsible person) to ensure the following requirements are met:

- No decontamination or cleaning agents are used that could cause a HAZARD as a result of a reaction with parts of the equipment or with material contained in the equipment.
- The instrument is properly decontaminated a) if hazardous material is spilled onto or into the equipment, and/or b) prior to having the instrument serviced at your facility or sending the instrument for repair, maintenance, trade-in, disposal, or termination of a loan (decontamination forms may be requested from customer service).
- Before using any cleaning or decontamination methods (except those recommended by the manufacturer), users should confirm with the manufacturer that the proposed method will not damage the equipment.

Safety and electromagnetic compatibility (EMC) standards

The instrument design and manufacture complies with the standards and requirements for safety and electromagnetic compatibility as noted in the following table:



Safety compliance

Reference	Description
EU Directive 2014/35/EU	European Union “Low Voltage Directive”
IEC 61010-1 EN 61010-1 UL 61010-1 CSA C22.2 No. 61010-1	<i>Safety requirements for electrical equipment for measurement, control, and laboratory use – Part 1: General requirements</i>
IEC 61010-2-010 EN 61010-2-010	<i>Safety requirements for electrical equipment for measurement, control and laboratory use – Part 2-010: Particular requirements for laboratory equipment for the heating of materials</i>
IEC 61010-2-081 EN 61010-2-081	<i>Safety requirements for electrical equipment for measurement, control and laboratory use – Part 2-081: Particular requirements for automatic and semi-automatic laboratory equipment for analysis and other purposes</i>

EMC

Reference	Description
Directive 2014/30/EU	European Union “EMC Directive”
EN 61326-1/ IEC 61326-1	<i>Electrical Equipment for Measurement, Control and Laboratory Use – EMC Requirements – Part 1: General Requirements</i>
AS/NZS CISPR 11	<i>Limits and Methods of Measurement of Electromagnetic Disturbance Characteristics of Industrial, Scientific, and Medical (ISM) Radiofrequency Equipment</i>
ICES-001, Issue 4	<i>Industrial, Scientific and Medical (ISM) Radio Frequency Generators</i>
FCC Part 15 Subpart B (47 CFR)	<i>U.S. Standard Radio Frequency Devices</i>

This equipment has been tested and found to comply with the limits for a Class A digital device, pursuant to part 15 of the FCC Rules. These limits are designed to provide reasonable protection against harmful interference when the equipment is operated in a commercial environment. This equipment generates, uses, and can radiate radio frequency energy and, if not installed and used in accordance with the instruction manual, may cause harmful interference to radio communications. Operation of this equipment in a residential area is likely to cause harmful interference in which case the user will be required to correct the interference at his own expense.

Environmental design

Reference	Description
Directive 2012/19/EU	European Union "WEEE Directive" – Waste electrical and electronic equipment
Directive 2011/65/EU	European Union "RoHS Directive" – Restriction of hazardous substances in electrical and electronic equipment
Directive 2006/66/EC	European Union "Battery Directive"

Chemical safety

-
-  **WARNING! GENERAL CHEMICAL HANDLING.** To minimize hazards, ensure laboratory personnel read and practice the general safety guidelines for chemical usage, storage, and waste provided below, and consult the relevant SDS for specific precautions and instructions:
- Read and understand the Safety Data Sheets (SDSs) provided by the chemical manufacturer before you store, handle, or work with any chemicals or hazardous materials. To obtain SDSs, see the "Documentation and Support" section in this document.
 - Minimize contact with chemicals. Wear appropriate personal protective equipment when handling chemicals (for example, safety glasses, gloves, or protective clothing).
 - Minimize the inhalation of chemicals. Do not leave chemical containers open. Use only with adequate ventilation (for example, fume hood).
 - Check regularly for chemical leaks or spills. If a leak or spill occurs, follow the manufacturer's cleanup procedures as recommended in the SDS.
 - Handle chemical wastes in a fume hood.
 - Ensure use of primary and secondary waste containers. (A primary waste container holds the immediate waste. A secondary container contains spills or leaks from the primary container. Both containers must be compatible with the waste material and meet federal, state, and local requirements for container storage.)
 - After emptying a waste container, seal it with the cap provided.
 - Characterize (by analysis if necessary) the waste generated by the particular applications, reagents, and substrates used in your laboratory.
 - Ensure that the waste is stored, transferred, transported, and disposed of according to all local, state/provincial, and/or national regulations.
 - **IMPORTANT!** Radioactive or biohazardous materials may require special handling, and disposal limitations may apply.
-

 **WARNING! HAZARDOUS WASTE (from instruments).** Waste produced by the instrument is potentially hazardous. Follow the guidelines noted in the preceding General Chemical Handling warning.

 **WARNING! 4L Reagent and Waste Bottle Safety.** Four-liter reagent and waste bottles can crack and leak. Each 4-liter bottle should be secured in a low-density polyethylene safety container with the cover fastened and the handles locked in the upright position.

Biological hazard safety



WARNING! Potential Biohazard. Depending on the samples used on this instrument, the surface may be considered a biohazard. Use appropriate decontamination methods when working with biohazards.



WARNING! BIOHAZARD. Biological samples such as tissues, body fluids, infectious agents, and blood of humans and other animals have the potential to transmit infectious diseases. All work should be conducted in properly equipped facilities using the appropriate safety equipment (for example, physical containment devices). Safety equipment also may include items for personal protection, such as gloves, coats, gowns, shoe covers, boots, respirators, face shields, safety glasses, or goggles. Individuals should be trained according to applicable regulatory and company/ institution requirements before working with potentially biohazardous materials. Follow all applicable local, state/provincial, and/or national regulations. The following references provide general guidelines when handling biological samples in laboratory environment.

- U.S. Department of Health and Human Services, *Biosafety in Microbiological and Biomedical Laboratories (BMBL)*, 5th Edition, HHS Publication No. (CDC) 21-1112, Revised December 2009; found at:
www.cdc.gov/biosafety/publications/bmb15/BMBL.pdf
 - World Health Organization, *Laboratory Biosafety Manual*, 3rd Edition, WHO/CDS/CSR/LYO/2004.11; found at:
www.who.int/csr/resources/publications/biosafety/Biosafety7.pdf
-

Documentation and support

Related documentation

Document	Publication number	Description
<i>QuantStudio™ 3 and 5 Real-Time PCR Systems Installation, Use, and Maintenance Guide</i>	MAN0010407	Describes the QuantStudio™ 3 and 5 Real-Time PCR Systems hardware and software and provides information on preparing, using, maintaining, and troubleshooting the system.
<i>QuantStudio™ Real-Time PCR System Help</i>	MAN0010422	Describes the QuantStudio™ 3 and 5 Real-Time PCR Systems touchscreen and provides procedures for configuration, calibration, and performing a run.
<i>QuantStudio™ Design and Analysis desktop Software Command-Line Application Guide</i>	MAN0010409	Describes how to use the command-line interface of the QuantStudio™ Design and Analysis desktop Software and provides the procedure to automate the creation of new experiment files and export data from existing files.
<i>QuantStudio™ Design and Analysis desktop Software User Guide</i>	MAN0010408	Describes how to perform the six different experiments on the QuantStudio™ Design and Analysis desktop Software
<i>QuantStudio™ Design and Analysis desktop Software Help</i>	MAN0010415	Describes the QuantStudio™ Design and Analysis desktop Software and provides procedures for common tasks.
<i>SAE Admin Console Help</i>	MAN0010417	Describes the Security, Audit, and e-Signature (SAE) Administrator Console and provides procedures for common tasks.
<i>SAE Admin Console User Guide</i>	MAN0010410	Describes how to use the Security, Audit, and e-Signature (SAE) Administrator Console.

Document	Publication number	Description
<i>QuantStudio™ Design and Analysis cloud Software Help</i>	MAN0010414	Describes the QuantStudio™ Design and Analysis cloud Software and provides procedures for common tasks.
<i>QuantStudio™ 3 and 5 Real-Time PCR Systems Site Preparation Guide</i>	MAN0010405	Explains how to prepare your site to receive and install the QuantStudio™ 3 and 5 Real-Time PCR Systems. Intended for personnel who schedule, manage, and perform the tasks required to prepare the site for installation of the QuantStudio™ 3 and 5 Real-Time PCR Systems.

Note: For additional documentation, see “Customer and technical support” on page 108.

Obtain information from the Help system

The instrument has a Help system that describes how to use each feature of the touchscreen. Touch  on the instrument touchscreen to access the Help system.

Customer and technical support

Visit [thermofisher.com/support](https://www.thermofisher.com/support) for the latest in services and support, including:

- Worldwide contact telephone numbers
- Product support, including:
 - Product FAQs
 - Software, patches, and updates
- Order and web support
- Product documentation, including:
 - User guides, manuals, and protocols
 - Certificates of Analysis
 - Safety Data Sheets (SDSs; also known as MSDSs)

Note: For SDSs for reagents and chemicals from other manufacturers, contact the manufacturer.

Limited product warranty

Life Technologies Corporation and/or its affiliate(s) warrant their products as set forth in the Life Technologies' General Terms and Conditions of Sale found on Life Technologies' website at www.thermofisher.com/us/en/home/global/terms-and-conditions.html. If you have any questions, please contact Life Technologies at www.thermofisher.com/support.

Index

A

- accessories 91
- add to method 34
- administrator profile 71

B

- Background calibration
 - create plate 48
 - description 41
 - plate, prepare 43
 - run 44
 - when to perform 40
- backup instrument 62
- barcode scan 31
- biohazard safety 106

C

- calibration
 - reminders 41, 42
 - Background 44
 - custom dye. *See* custom dye
 - custom melt 60
 - Dye 44
 - plate, prepare 43
 - reminders 41, 42
 - ROI/Uniformity 44
 - schedule 40
 - status 41, 42
 - transfer results 46
 - view images 46
 - workflow 42
- calibration failure, troubleshoot 47
- Cloud server, select location 75
- Comparative CT experiment 17
- computer
 - connection to instrument or LAN 84
 - connections 81
 - requirements for desktop software 82
 - set up 79
- connect to network, workflow 77
- consumables
 - 384-well 89

- 96-well 0.1-mL 90
- 96-well 0.2-mL 88
- contamination, identify 47
- custom dye
 - add to the software 57
 - calibration plate, create 57
 - calibration, perform 58
 - dilution guidelines 54
 - optimal concentration 56
 - wavelength requirements 54
- custom dye calibration, workflow 54
- custom dye dilution plate, prepare 54
- custom dyes 12
- custom melt calibration 60

D

- data collection 12
- date and time 76
- desktop software, download and install 82
- disk space message
- documentation, related 107
- Dye calibration
 - description 41
 - plate, prepare 43
 - run 44
 - when to perform 40
- dyes
 - custom 12, 54
 - system 11

E

- experiment
 - copy or delete 39
 - create from template 29
 - edit 31
 - run from saved file 29
 - run last 30
 - transfer 38
- experiment properties. *See* properties
- experiment types 17

F

factory defaults 74
 files, copy or delete 39
 firewall ports 85
 fuses, replace 66

G

Genotyping experiment 17
 guest profile
 disable 73
 limitations 23

H

Help system, access 108
 home screen, parts of 21

I

installation
 before you begin 78
 desktop software 82
 workflow 77
 installation specification 50
 instrument
 profile, create 23
 connections 81
 enable for monitoring in cloud software 73
 move 68
 name 75
 overview 10
 parts of 13
 power off 67
 power on 20, 67
 prepare to move or ship or store 67
 return for service 68
 instrument filters 11
 instrument layout 92
 instrument settings 25
 instrument specification 92
 instrument verification. *See* RNase P verification

L

limited product warranty 109
 link to a Cloud account 24
 load plate 36
 lock the touchscreen 38

M

maintenance 62

Melt Curve experiment 17
 method

 add steps 33
 edit 32
 parts of 33
 pause 34
 ramp rate 34

N

network
 configurations supported 84
 guidelines and best practices 85
 wired connection set up 74
 wireless connection set up 75
 networking 84

O

online Help. *See* Help system

P

pause run 37
 performance verification. *See* RNase P verification
 PIN reset 71
 plate wells, define 35
 Presence/Absence experiment 17
 profiles
 administrator 71
 delete 71
 edit 72
 guest, disable 73
 instrument 23
 link to Cloud 24
 require sign-in 73
 reset PIN 71
 sign in 23
 view all 71
 properties, define 31
 protocol. *See* method

Q

QuantStudio Design and Analysis desktop software,
 download and install 82

R

related documentation 107
 Relative Standard Curve experiment 17
 Replace with index term
 require sign in 73
 restore instrument 62

RNase P verification
 analytical performance 50
 plate description 49
 plate, prepare 50
 run 51

ROI/Uniformity calibration
 description 41
 plate, prepare 43
 run 44
 when to perform 40

run
 pause or stop 37
 post-PCR 12
 real-time 12

run history 38
 run last experiment 30
 run protocol. *See* method

S

SAE mode (Security, Audit, and e-Signature) 72

safety, biohazard 106

sample block
 clean 63
 decontaminate 63

settings 25

sign in, require 73

sign out
 profile 24
 timer, set 76

sleep mode 66

software features 14

software updates 73

Standard Curve experiment 17

standby mode 66

startup wizard 79
 steps, add to method 33
 stop run 37
 supported dyes 11
 symbols, safety 98
 system dyes 11

T

terms and conditions 109
 thermal cycling protocol. *See* method
 third-party software 16
 transfer files 38
 troubleshoot 87

U

unload plate 36
 unpack instrument 78
 use the instrument, workflow 28

V

verification failure, troubleshoot 53

W

warranty 109
 well details 37
 workflow, use the instrument 28

Z

zoom 37

For support visit thermofisher.com/support or email techsupport@lifetech.com
thermofisher.com

16 December 2015

ThermoFisher
SCIENTIFIC